

**HP 35665A Dynamic Signal Analyzer**  
**Installation and Verification Guide**

**Serial Numbers**  
3137A and greater



**HP Part Number: 35665-90029**  
**Microfiche Part Number 35665-90229**  
**Printed in U.S.A.**

**Print Date: September 1991**

©Hewlett-Packard Company, 1991. All rights reserved.  
8600 Soper Hill Road Everett, Washington 98205-1298 U.S.A.



## Registration Card

Make sure you send in the product registration card located in the red brochure included in your HP 35665A shipping carton. This assures that you will hear about future HP 35665A product and service updates. If the brochure has been misplaced, simply mail or fax the following information to the indicated address/fax number.

- Serial Number:
- Your Name:
- Position:
- Company Name:
- Division:
- Mail Stop:
- Street:
- City:
- State or Province:
- Postal Code:
- Country:
- Telephone: ( )-

Mail to:

ATTN: Quality and Productivity MS230  
Hewlett-Packard Company  
Lake Stevens Instrument Division  
8600 Soper Hill Rd.  
Everett, WA 98205-1298

Or FAX:

(206)335-2828  
No cover sheet is required.  
Quality and Productivity Department MS230





## Safety Summary

The following general safety precautions must be observed during all phases of operation, service, and repair of this instrument. Failure to comply with these precautions or with specific warnings elsewhere in this manual violates safety standards of design, manufacture, and intended use of the instrument. Hewlett-Packard Company assumes no liability for the customer's failure to comply with these requirements. This is a Safety Class 1 instrument.

### Ground The Instrument

To minimize shock hazard, the instrument chassis and cabinet must be connected to an electrical ground. The instrument is equipped with a three-conductor ac power cable. The power cable must either be plugged into an approved three-contact electrical outlet or used with a three-contact to two-contact adapter with the grounding wire (green) firmly connected to an electrical ground (safety ground) at the power outlet. The power jack and mating plug of the power cable meet International Electrotechnical Commission (IEC) safety standards.

### Do Not Operate In An Explosive Atmosphere

Do not operate the instrument in the presence of flammable gases or fumes. Operation of any electrical instrument in such an environment constitutes a definite safety hazard.

### Keep Away From Live Circuits

Operating personnel must not remove instrument covers. Component replacement and internal adjustments must be made by qualified maintenance personnel. Do not replace components with power cable connected. Under certain conditions, dangerous voltages may exist even with the power cable removed. To avoid injuries, always disconnect power and discharge circuits before touching them.

### Do Not Service or Adjust Alone

Do not attempt internal service or adjustment unless another person, capable of rendering first aid and resuscitation, is present.

### Do Not Substitute Parts or Modify Instrument

Because of the danger of introducing additional hazards, do not install substitute parts or perform any unauthorized modification to the instrument. Return the instrument to a Hewlett-Packard Sales and Service Office for service and repair to ensure the safety features are maintained.

### Dangerous Procedure Warnings

Warnings, such as the example below, precede potentially dangerous procedures throughout this manual. Instructions contained in the warnings must be followed.

---

#### Warning



**Dangerous voltages, capable of causing death, are present in this instrument. Use extreme caution when handling, testing, and adjusting.**

---

## Safety Symbols

The following safety symbols are used throughout this manual and in the instrument. Familiarize yourself with each symbol and its meaning before operating this instrument.

### General Definitions of Safety Symbols Used On Equipment or In Manuals.



Instruction manual symbol: the product will be marked with this symbol when it is necessary for the user to refer to the instruction manual in order to protect against damage to the instrument.



Indicates dangerous voltage (terminals fed from the interior by voltage exceeding 1000 volts must be so marked.)

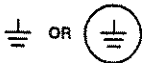

Protective conductor terminal. For protection against electrical shock in case of a fault. Used with field wiring terminals to indicate the terminal which must be connected to ground before operating equipment.



Low-noise or noiseless, clean ground (earth) terminal. Used for a signal common, as well as providing protection against electrical shock in case of a fault. A terminal marked with this symbol must be connected to ground in the manner described in the installation (operating) manual, and before operating the equipment.



Frame or chassis terminal. A connection to the frame (chassis) of the equipment which normally includes all exposed metal structures.



Alternating current (power line).



Direct current (power line).



Alternating or direct current (power line).

#### Warning



The **WARNING** sign denotes a hazard. It calls attention to a procedure, practice, condition or the like, which if not correctly performed or adhered to, could result in injury or death to personnel.

#### Caution



The **CAUTION** sign denotes a hazard. It calls attention to an operating procedure, practice, condition or the like, which, if not correctly performed or adhered to, could result in damage to or destruction of part or all of the product.

#### Note



The **NOTE** sign denotes important information. It calls attention to procedure, practice, condition or the like, which is essential to highlight.

## Guide to HP 35665A Documentation

If you are thinking about...	And you want to...	Then read...
<p>◆ Unpack and install the HP 35665A</p>	<p>Install the HP 35665A Dynamic Signal Analyzer</p> <p>Do operation verification or performance verification tests</p>	<p><i>HP 35665A Installation and Verification Guide</i></p> <p><i>HP 35665A Installation and Verification Guide</i></p>
<p>◆ Getting started</p>	<p>Make your first measurements with your new analyzer</p> <p>Review measurement basics</p> <p>Learn what each key does</p>	<p><i>HP 35665A Quick Start Guide</i></p> <p><i>HP 35665A Concepts Guide</i></p> <p><i>HP 35665A Operator's Reference</i> or use the analyzer's [ <b>Help</b> ] key</p>
<p>◆ Making measurements</p>	<p>Learn how to make typical measurements with the HP 35665A</p> <p>Understand each of the analyzer's instrument modes</p>	<p><i>HP 35665A Operator's Guide</i></p> <p><i>HP 35665A Concepts Guide</i></p>
<p>◆ Creating automated measurements</p>	<p>Learn the HP Instrument BASIC interface</p> <p>Record keystrokes for a particular measurement</p> <p>Program with HP Instrument BASIC</p>	<p><i>Using HP Instrument BASIC with the HP 35665A</i></p> <p><i>HP 35665A Operator's Guide</i></p> <p><i>HP Instrument BASIC User's Handbook</i></p>
<p>◆ Remote operation</p>	<p>Learn about the HP-IB</p> <p>Learn how to program with HP-IB</p> <p>Find specific HP-IB commands</p>	<p><i>HP-IB Programming with the HP 35665A</i></p> <p><i>HP-IB Programming with the HP 35665A</i></p> <p><i>HP 35665A HP-IB Commands: Quick Reference</i></p>
<p>◆ Servicing the analyzer</p>	<p>Adjust, troubleshoot, or repair the analyzer</p>	<p><i>HP 35665A Service Guide</i></p>





# Table of Contents

---

## Chapter 1: Introducing the HP 35665A

Instrument Description	1-1
Options	1-1
Accessories	1-2
Firmware Version Code	1-3
Serial Numbers	1-3
Recommended Test Equipment	1-4
Specifications	1-7

## Chapter 2: Preparing the Analyzer for Use

How to Use This Chapter	2-1
Incoming Inspection	2-1
Incoming Tests	2-1
Power Requirements	2-2
Power Cable and Grounding Requirements	2-3
Operating Environment	2-5
Analyzer Cooling	2-5
Port 1 Interface Connection	2-5
HP-IB System Interface Connections	2-6
Screen (CRT) Cleaning	2-6
Installation	2-7
Installing the Optional Keyboard	2-7
Turning on the HP 35665A	2-8
Need Assistance?	2-9
Storage and Shipment	2-9
Storage	2-9
Shipment	2-9

## Chapter 3: Verifying Specifications

How to Use This Chapter	3-1
Overview	3-1
Features of the Program	3-2
Test Duration	3-3
Calibration Cycle	3-3
Recommended Test Equipment	3-4
Program Controlled Test Equipment	3-4
Measurement Uncertainty	3-5
Operation Verification and Performance Tests	3-6

Table of Contents (Continued)

Specifications and Performance Tests . . . . .	3-7
How to Load the Program . . . . .	3-8
How to Run the Program in Semiautomated Mode . . . . .	3-9
How to Run the Program Without a Printer . . . . .	3-12
How to Run the Program in Manual Mode . . . . .	3-14
Tests Requiring Equipment Connection Changes . . . . .	3-16
Test Descriptions and Equipment Setup . . . . .	3-18
Self Test . . . . .	3-18
DC Offset . . . . .	3-19
Amplitude Accuracy . . . . .	3-20
Flatness . . . . .	3-21
Amplitude Linearity . . . . .	3-22
Amp_Phase Match (Amplitude and Phase Match) . . . . .	3-23
Anti-Alias Filter . . . . .	3-24
Frequency Accuracy . . . . .	3-25
Input Coupling . . . . .	3-26
Single Channel Phase Accuracy . . . . .	3-27
Input Resistance . . . . .	3-28
Input Capacitance . . . . .	3-29
Harmonic Distortion . . . . .	3-32
Intermodulation Distortion . . . . .	3-33
Spurious Signals . . . . .	3-35
Noise . . . . .	3-36
Cross Talk . . . . .	3-37
Source Amplitude Accuracy . . . . .	3-39
Source Flatness . . . . .	3-40
Source Distortion . . . . .	3-41
Source Output Resistance . . . . .	3-42
Softkey Descriptions . . . . .	3-44
ITM_35665A Main Menu . . . . .	3-44
Start Testing Menu . . . . .	3-45
Test Configuration Menu . . . . .	3-46
Equipment Configuration Menu . . . . .	3-47
Title Page Menu . . . . .	3-48
Measurement Uncertainty . . . . .	3-49
Performance Test Record . . . . .	1 thru 12
Operation Verification Test Record . . . . .	1 thru 7

**Index**

# Introducing the HP 35665A

---

## Instrument Description

The HP 35665A Dynamic Signal Analyzer is a two-channel FFT spectrum/network analyzer with a frequency range that extends from 0.19531 Hz to 102.4 kHz in single channel mode and from 0.097656 to 51.2 kHz in two channel mode. The analyzer has a built-in signal source providing random noise, burst random noise, periodic chirp, burst chirp, pink noise, and fixed sine. Measurements can be saved to an internal 3.5-inch flexible disk drive, an external HP SS-80 disk drive, or to internal non-volatile memory. Plots and prints of the measurements can be made directly to HP-IB printers and plotters. The HP 35665A Dynamic Signal Analyzer also supports the HP Instrument BASIC programming language (IBASIC).

On the front panel there are four connectors: a BNC connector for channel 1 input, a BNC connector for channel 2 input, a BNC connector for source output, and a connector for an external PC-style keyboard. On the rear panel there are also four connectors: a BNC connector for the external trigger input, a BNC connector for the tachometer input, a 25-pin connector for the HP-IB, and a 9-pin connector only for use with IBASIC.

---

## Options

The following options are available to upgrade your HP 35665A Dynamic Signal Analyzer. Order HP 35665U followed by the option number below:

- 1D0 Computed Order Tracking (requires option 1C1 or ANA)
- 1D1 Real-time Octave Measurements
- 1D2 Swept-Sine Measurement
- 1D3 Curve Fit and Synthesis
- 1D4 Arbitrary Waveform Source
- 1C2 HP Instrument BASIC
- 1C1 Add 2 MByte memory
- ANA Add 6 MByte memory

---

### Note



Order either option 1C1 or ANA but not both. Only one of these options can be installed.

---

## Accessories

The accessories listed in table 1-1 are supplied with the HP 35665A Dynamic Signal Analyzer.

**Table 1-1. Supplied Accessories**

Accessory	Part Number
Line Power Cable	See figure 2-2
Plastic Transportation Disk	HP 5061-2819
Standard Data Format Utilities	HP 5061-8037
<i>HP 35665A Installation and Verification Guide</i>	HP 35665-90029
<i>HP 35665A Operator's Reference</i>	HP 35665-90027
<i>HP 35665A Quick Start Guide</i>	HP 35665-90035
<i>HP 35665A Operator's Guide</i>	HP 35665-90026
<i>HP 35665A Concepts Guide</i>	HP 35665-90028
<i>HP-IB Programming with the HP 35665A</i>	HP 35665-90030
<i>HP 35665A HP-IB Commands: Quick Reference</i>	HP 35665-90033

The accessories listed in table 1-2 are available for the HP 35665A.

**Table 1-2. Available Accessories**

Accessory	Part Number
Rack Mount Kit	HP 35660-86010
Box of ten 3.5-inch double-sided, double-density disks	HP 92192A
<i>Using HP Instrument BASIC with the HP 35665A</i>	HP 35665-90032
<i>HP Instrument BASIC User's Handbook</i>	HP E2083-90000
Service Kit	HP 35660-84401
HP 35665A Service Guide	HP 35665-90031
PC Style 101-key keyboard	
U.S. ASCII	HP C1405A #ABA
U.K. English	HP C1405A #ABU
German	HP C1405A #ABD
French	HP C1405A #ABF
Italian	HP C1405A #ABZ
Spanish	HP C1405A #ABE
Swedish	HP C1405A #ABS
Keyboard cable	HP 5081-2249
Transit Case	HP 9211-2663

---

## Firmware Version Code

As with changes to the instrument hardware, Hewlett-Packard also makes changes to its firmware. To determine which version of firmware is in your analyzer, press the following keys:

[ System Utility ]  
[ S/N VERSION ]

An information block appears on the screen for about five seconds (pressing [ S/N VERSION ] repeats the information). The second line of this information block contains the firmware version code.

---

## Serial Numbers

Hewlett-Packard makes frequent improvements to its products to enhance their performance, usability, or reliability and to control costs. HP service personnel have access to complete records for each type of equipment, based on the equipment's serial number. Whenever you contact HP about your analyzer, have the complete serial number available to ensure obtaining the most complete and accurate information possible.

A serial number label is attached to the rear of the analyzer. The serial number has two parts — the prefix (the first four numbers and a letter) and the suffix (the last five numbers).

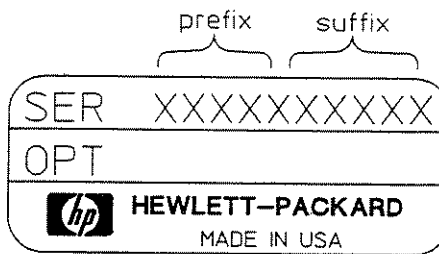

Figure 1-1. Serial Number Label

You can also access the serial number from the front panel by pressing the following keys:

[ System Utility ]  
[ S/N VERSION ]

An information block appears on the screen for about five seconds (pressing [ S/N VERSION ] repeats the information). The first line of this information block contains the analyzer serial number.

## Recommended Test Equipment

Table 1-3 lists the recommended equipment needed to test the performance of the HP 35665A Dynamic Signal Analyzer. Table 1-4 lists additional equipment needed to adjust and troubleshoot the analyzer. Other equipment may be substituted for the recommended model if it meets or exceeds the listed critical specifications. When substitutions are made, you may have to modify the procedures to accommodate the different operating characteristics.

**Table 1-3. Recommended Test Equipment**

Instrument	Critical Specifications	Recommended Model
AC Calibrator	10 Hz to 102.4 kHz; 1 mV to 10V Amplitude Accuracy: $\pm 0.1\%$ phase locking capability	Fluke 5700A Alternatives: Fluke 5200A Datron 4200, 4700, or 4708 HP 745A
Frequency Synthesizer	Frequency Range: 10 Hz to 1 MHz Frequency Accuracy: $\geq 7.5$ ppm Amplitude Accuracy: 0.2 dB from 1 Hz to 100 kHz 1 dB from 100 kHz to 1 MHz Harmonic Distortion: $\geq -70$ dBc Spurious: $\leq -70$ dBc $< \pm 1$ deg phase shift between output and sync	HP 3326A Alternative: (2) HP 3325A Opt 001 (1) HP 339A (2) 100 k $\Omega$ resistors
Digital Multimeter	5 1/2 digit True rms ac Voltage: 30 Hz to 100 kHz; 0.1 to 500V; $\pm 0.1\%$ ; $\geq 1$ M $\Omega$ input impedance dc Voltage: 1V to 300V; $\pm 0.1\%$	HP 3458A Alternatives: HP 3456A, HP 3455A, HP 3478A
Feedthrough Termination (2)	50 $\Omega$ : $\pm 2\%$ at dc	Pomona Elect Model 4119-50 Alternatives: HP 11048C, HP 10100C
Cables (2)	BNC-to-Dual Banana Dual Banana-to-Dual Banana BNC-to-BNC 30 cm BNC-to-BNC 122 cm	HP 11001-60001 HP 11000-60001 HP 8120-1838 HP 8120-1840
Adapters	BNC (m)-to-Dual Banana Plug BNC (f)-to-Dual Banana Plug BNC (f)-to-BNC (f) BNC Tee (m)(f)(f)	HP 10110B HP 1251-2277 HP 1250-0080 HP 1250-0781
Resistor (2)†	Value: 100 k $\Omega$ Accuracy: 1% Power: 0.25W	HP 0757-0465

† See figure 1-2 for suggested assembly.

The following illustration is a suggested assembly for the 100 kΩ series resistor. This assembly is required for the following performance tests:

Input Capacitance  
Intermodulation Distortion

Resistance	Tolerance	Power	HP Part Number
100 kΩ	1%	0.25 W	0757-0465

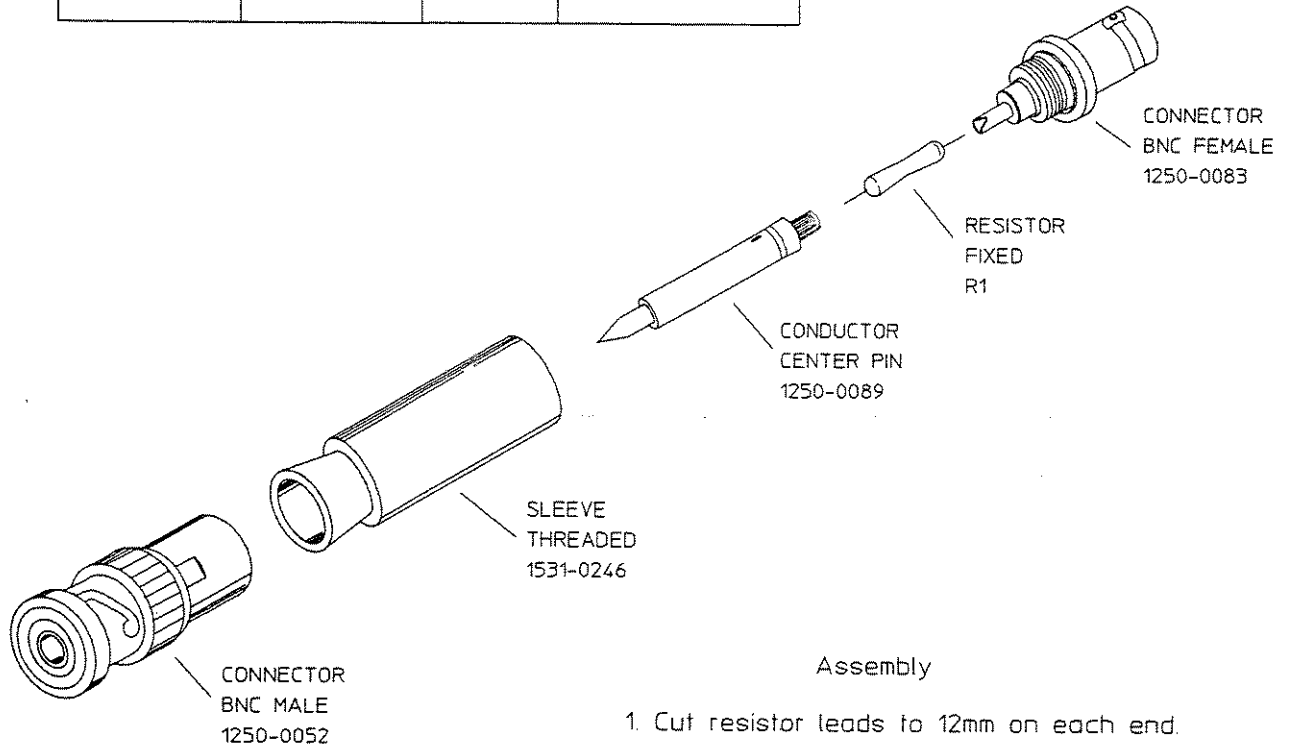

Assembly

1. Cut resistor leads to 12mm on each end.
2. Solder one resistor lead to the center conductor of the BNC FEMALE connector.
3. Solder the CONDUCTOR CENTER PIN to the other lead of the resistor.
4. Screw the SLEEVE and the BNC MALE connector into place. Tighten securely.

**Figure 1-2. 100 kΩ  
Series Resistor**

**Table 1-4. Additional Recommended Test Equipment †**

Instrument	Critical Specifications	Recommended Model
Frequency Counter	Frequency Range: 0 Hz to 100 MHz Frequency Accuracy: 7.5 ppm or better at 20 MHz	HP 5350B Alternatives: HP 5351B, HP 5335A
Oscilloscope	Bandwidth: >50 MHz Two Channel; External Trigger; 1 M $\Omega$ Input	HP 54111D Alternatives: HP 1980B, HP 1740
Oscilloscope Probe	Impedance: $\geq$ 1 M $\Omega$ Division Ratio: 10:1 Maximum Voltage: $\geq$ 20 Vdc	HP 10431A
Logic Probe	TTL/CMOS Maximum Clock: >25 MHz	HP 545A Alternatives: HP 5006A, HP 5005A/B
Spectrum Analyzer	Frequency Range: 10 Hz to 100 kHz Dynamic Range: $\geq$ 70 dBV	HP 3562A Alternatives: HP 3561A, HP 3585A/B
Serial Port Connector	RS-232-C, 9-pin male	HP 1251-0216
HP 35665A Service Kit	Includes: Power Supply Test Board Fast Bus Extender Cable Front-Panel Extender Cable Interconnect Extender Cable IIC/Power Extender Cable Phono Cable Phono Plug to BNC Cable BNC-to-SMB Cable SMB-to-SMB Adapter Capacitive Load	HP 35660-84401 Includes: HP 35672-66590 HP 35660-61621 HP 35672-61621 HP 35660-61623 HP 35660-61622 HP 8120-4492 HP 03326-61618 HP 03585-61616 HP 1250-0669 HP 35660-64401

† Not required for performance tests — only required for adjustment and troubleshooting procedures.



## Specifications

Specifications describe the instrument's warranted performance and apply within  $\pm 5^\circ\text{C}$  and 2 hours of last self-calibration. Specifications designated as "Typical" reflect supplemental, non-warranted characteristics.

Frequency	
<b>Range</b>	
One Channel Mode (Ch1)	102.4 kHz (extends to 115 kHz with zoom, but with unspecified performance)
Two Channel Mode (Chs 1 and 2)	51.2 kHz (extends to 57.5 kHz with zoom, but with unspecified performance)
<b>Resolution</b>	
100, 200, 400 or 800 lines resolution Frequency resolution = frequency span/number of lines resolution	
Minimum frequency resolution	
One Channel Mode	244 $\mu\text{Hz}$
Two Channel Mode	122 $\mu\text{Hz}$
<b>Spans</b>	
One Channel Mode	102.4 kHz to 0.19531 Hz in 2 $\times$ steps
Two Channel Mode	51.2 kHz to 0.097656 Hz in 2 $\times$ steps
<b>Accuracy</b>	$\pm 30$ ppm
<b>Real Time Bandwidth</b> (FFT spans for continuous data acquisition)	
From the preset condition	$\leq 6.4$ kHz span
Fast average On	$\leq 12.8$ kHz span (1/2 the span in 2 channel mode)
<b>Measurement Rate</b>	
At the preset condition, 401 point FFT display, fast average On	
One Channel Mode	$\geq 33$ averages/second (typical)
Two Channel Mode	$\geq 15$ averages/second (typical)
<b>Display Update Rate</b>	$\geq 8$ updates/second (typical)
At the preset condition, 401 point FFT display, fast average Off	

Window Parameter	Uniform	Hanning	Flat Top
<b>Window -3 dB Bandwidth †</b>	0.250% of span	0.370% of span	0.900% of span
<b>Window Noise Equivalent Bandwidth †</b>	0.250% of span	0.375% of span	0.955% of span
<b>Window Flatness</b> (signal within $\pm 1/2$ bin)	+0, -4.0 dB	+0, -1.5 dB	+0, -0.01 dB
<b>Window Shape Factor</b> (-60 dB bandwidth/ -3 dB bandwidth)	716	9.1	2.6

† For 400 line measurements. For 800 line measurements, divide values by 2. For 200 line measurements, multiply values by 2. For 100 line measurements, multiply values by 4.

### Amplitude and Inputs

<b>Input Ranges</b> (full scale) (auto-range capability)	+27 dBVrms (31.7 Vpk) to -51 dBVrms (3.99 mVpk) in 2 dB steps
<b>Amplitude Resolution</b> (13 bits less 2 dB over-range)	0.016% of full scale (typical)
<b>Full Span FFT Noise Floor</b> Excludes coherent responses. Flat top window, anti-alias filter in, Vs=0, Rs=50 $\Omega$ , 64 rms averages Input Ranges:	<-76 dBfs <(-112 - Range) dBfs
<b>Absolute Amplitude Accuracy</b> (FFT) dc coupled, center of bin (a combination of full scale accuracy, full scale flatness, and amplitude linearity)	$\pm 2.92\%$ (0.25 dB) of reading $\pm 0.025\%$ of full scale
<b>FFT Full Scale Accuracy</b> at 1 kHz(0 dBfs) Ranges:	$\pm 0.15$ dB (1.74%) +27 dBVrms to -39 dBVrms -41 dBVrms to -51 dBVrms
<b>FFT Full Scale Flatness</b> (0 dBfs) Relative to 1 kHz Ranges: +27, +9, -11 dBVrms	$\pm 0.2$ dB (2.33%)
<b>FFT Amplitude Linearity</b> at 1 kHz Vs = 0 to -72 dBfs Range: +27 dBVrms	$\pm 0.58\%$ (0.05 dB) of reading $\pm 0.025\%$ of full scale

**FFT Cross-Channel Gain Accuracy**

Frequency response mode,  
Ch1 range = Ch2 range, ac coupled,  
periodic chirp, uniform window,  
0 Hz < freq ≤ 51.2 kHz  
Source = full scale ± 0.04 dB (0.46%)  
10 rms averages, -11 to +27 dBV  
ranges  
100 rms averages, -51 dBV range  
Source = -20 dB full scale ± 0.08 dB (0.92%)  
200 rms averages, -11 to +27 dBV  
ranges  
2000 rms averages, -51 dBV range

**FFT Window Flatness**

(signal within ± 1/2 bin)  
Uniform +0, -4.0 dB  
Hanning +0, -1.5 dB  
Flat Top +0, -0.01 dB

**Residual dc Response (FFT)**

Frequency display, Vs = 0V,  
Rs = 50Ω, 3.2 kHz span  
Ranges:  
+27 dBVrms to -35 dBVrms <-30 dBfs  
-37 dBVrms to -51 dBVrms <-20 dBfs

**Spurious and Residual Responses** <-72 dBfs

Single tone (in band), ≤ 0 dBfs,  
Rs = 50Ω

**Baseband Mode Alias Responses** <-72 dBfs

Start frequency = 0 Hz,  
single tone (out of band), ≤ 0 dBfs,  
≤ 1 MHz ( ≤ 200 kHz with ICP On)

---

**Input Noise**

---

**Input Noise Level**

Flat top window, anti-alias filter in,  
-51 dBVrms range, Rs = 50  
> 1280 Hz <-140 dBVrms/√Hz  
160 Hz to 1.28 kHz (6.4 kHz span) <-130 dBVrms/√Hz

**NOTE: To calculate noise as dBfs:**

Noise(dBfs) = Noise(dBV/√Hz) + 10LOG(NBW) - Range(dBVrms);  
where NBW (noise equivalent bandwidth) =  
0.955% of span for flat top window  
0.375% of span for hanning window  
0.250% of span for uniform window

---

**FFT Dynamic Range**

---

**Full Span FFT Noise Floor**

Excludes coherent responses.  
Flat top window, anti-alias filter in,  
Vs=0, Rs=50, 64 rms averages  
Input Range:  
27 dBVrms to -35 dBVrms <-76 dBfs (-85 dBfs typical)  
-37 dBVrms to -51 dBVrms <(-112 - range) dBfs

**Spurious Free Dynamic Range** <-72 dBfs

(includes spurs, harmonic  
distortion, intermodulation  
distortion, alias products)  
Excludes zoom mode alias  
responses at extremes of span.  
Total signal level ≤ 0 dBfs,  
out-of-band signals ≤ 1 MHz  
( ≤ 200 kHz with ICP On)

**Zoom Mode Alias Responses**

At less than full span, single tone  
(out of band), ≤ 1 MHz, ≤ 0 dBfs  
1.5% to 98.5% of frequency span <-72 dBfs  
Lower and upper 1.5% of  
frequency span <-65 dBfs

**Harmonic Distortion** <-72 dBfs

Single tone (in band), ≤ 0 dBfs

**ADC & Multiplexer Harmonic** <-72 dBfs

**Distortion Alias Responses**  
single tone ≤ 102.4 kHz, ≤ 0 dBfs

**Intermodulation Distortion** <-72 dBfs

Two tones (in band), ≤ -6.02 dBfs

---

**Phase**

---

**Single Channel FFT Accuracy**

± 4.0 deg  
Chs 1 and 2 relative to external trigger, 16 rms  
averages, center of bin, dc coupled, 0 dBfs to -50  
dBfs only, 0 Hz < freq ≤ 10.24 kHz only

**NOTE: Wrapped phase displays a ± 180 degree range.** For  
hanning and flat top windows, phase is relative to the center of the  
time record. For uniform, force, and exponential windows, phase is  
relative to the beginning of the time record.

**FFT Cross-Channel Phase Accuracy**

Frequency response mode, center of bin, Ch1  
range = Ch2 range, ac coupled, periodic chirp,  
uniform window, 0 Hz < freq ≤ 51.2 kHz  
Source = full scale ± 0.5 deg  
10 rms averages, -11 to +27 dBV ranges  
100 rms averages, -51 dBVrms range  
Source = -20 dB full scale ± 0.5 deg  
200 rms averages, -11 to +27 dBV ranges  
2000 rms averages, -51 dBVrms range

**FFT Cross-Channel Gain Accuracy**

Frequency response mode, Ch1 range = Ch2  
range, ac coupled, periodic chirp, uniform window,  
0 Hz < freq ≤ 51.2 kHz  
Source = full scale ± 0.04 dB  
10 rms averages, -11 to +27 dBV ranges (0.46%)  
100 rms averages, -51 dBV range  
Source = -20 dB full scale ± 0.08 dB  
200 rms averages, -11 to +27 dBV ranges (0.92%)  
2000 rms averages, -51 dBV range

**Time Domain**

<b>Input Ranges</b> (full scale)	31.7 Vpk to 3.99 mVpk in 2 dB steps
<b>Amplitude Resolution</b> (13 bits less 2 dB over-range)	0.016% of full scale (typical)
<b>DC Amplitude Accuracy</b> Anti-alias filter <i>On</i> and <i>Off</i> Ranges:	
+27 dBVrms to -35 dBVrms	4.0% of full scale
-37 dBVrms to -51 dBVrms	5.0% of full scale
<b>Rise Time</b> Histogram/time mode, unfiltered time display, -1V to 0V test pulse	< 11.4 $\mu$ s (limited by sampling period)
<b>Settling Time</b> Histogram/time mode, unfiltered time display, -1V to 0V test pulse	< 16 $\mu$ s to 1% (limited by sampling period)
<b>Pulse Aberrations</b> Peak aberration relative to the mode-mode (most common values), histogram/time mode, unfiltered time display, -1 V to 0 V test pulse	<3%
<b>Sampling Period</b> <i>One Channel Mode</i>	3.815 $\mu$ s(1/262144 Hz) to 2s in 2 $\times$ steps
<i>Two Channel Mode</i>	7.629 $\mu$ s(1/131072 Hz) to 4s in 2 $\times$ steps

**Dual Channel**

<b>FFT Cross-Channel Phase Accuracy</b> Frequency response mode, center of bin, Ch1 range = Ch2 range, ac coupled, periodic chirp, uniform window, 0 Hz < freq $\leq$ 51.2 kHz <i>Source = full scale</i>	$\pm 0.5$ deg
10 rms averages, -11 to +27 dBV ranges	
100 rms averages, -51 dBV range	
<i>Source = -20 dB full scale</i>	$\pm 0.5$ deg
200 rms averages, -11 to +27 dBV ranges	
2000 rms averages, -51 dBV range	
<b>FFT Cross-Channel Gain Accuracy</b> Frequency response mode, Ch1 range = Ch2 range, ac coupled, periodic chirp, uniform window, 0 Hz < freq $\leq$ 51.2 kHz <i>Source = full scale</i>	$\pm 0.04$ dB (0.46%)
10 rms averages, -11 to +27 dBV ranges	
100 rms averages, -51 dBV range	
<i>Source = -20 dB full scale</i>	$\pm 0.08$ dB (0.92%)
200 rms averages, -11 to +27 dBV ranges	
2000 rms averages, -51 dBV range	

**Input Characteristics**

<b>Input Impedance</b>	1 M $\Omega$ $\pm$ 10% $\leq$ 100 pF
<b>Low Side to Chassis Impedance</b> <i>Floating Mode</i>	1 M $\Omega$ $\pm$ 30% (typical) <0.01 $\mu$ F (typical)
<i>Grounded Mode</i>	$\leq$ 100 $\Omega$
<b>Input Capacitance:</b> <b>Range to Range Variation</b>	$\leq$ 6 pF
<b>AC Coupling</b> (Rs = 50 $\Omega$ )	<3 dB rolloff at 1 Hz
<b>Common Mode Rejection</b> Floating mode, single tone at or below 1 kHz, Rds = 0, Rcms = 50 Ranges:	
-51 dBVrms to -11 dBVrms	>80 dB (typical)
-9 dBVrms to +9 dBVrms	>60 dB (typical)
+11 dBVrms to +27 dBVrms	>40 dB (typical)
<b>NOTE:</b> CM (dBfs) = CM signal input (dBVrms) - CMR (dB) - Range (dBVrms)	
<b>Common Mode Range</b> (floating mode)	$\pm 4$ Vpk
<b>ICP Signal Conditioning</b> Current source Open circuit voltage	4.25 $\pm$ 1.5 mA +26 to +32 Vdc
<b>A-Weight Filter</b> Conforms to ANSI Standard S1.4-1983; and to IEC 651-1979	Type 0 Tolerance

<b>Crosstalk</b> Input channels and source-to-input, receiving channel Rs = 50 $\Omega$	<-130 dB below signal or <-72 dBfs of receiving channel, whichever response is greater in amplitude
--	---

**Trigger**

<b>Trigger Modes</b> Internal Trigger, Source Trigger, External TTL Trigger, HP-IB Trigger	
<b>Maximum Trigger Delay</b> Post Trigger Pre Trigger	8191 seconds 8191 samples
The Ch1 trigger cannot be further than $\pm 7168$ samples from the Ch2 trigger.	
<b>Trigger Resolution and Sample Period</b>	1 Fspan $\times$ 2.56
<b>Internal Trigger Level Accuracy</b> + and - slopes	$\pm 10.0\%$ of full scale

---

**Tachometer**

---

<b>Pulses per Revolution</b>	1/2, 1 to 2048 (integer steps)
<b>RPM Accuracy</b>	± 100 ppm
<b>Trigger Level Range</b>	
Low range	-4V to +4V
High range	-20V to +20V
Triggering is not specified beyond 20 V.	
<b>Trigger Level Resolution</b>	
Low range	100 mV
High range	500 mV
<b>Maximum Trigger Input Level</b>	± 25 Vpk
<b>Trigger Level Accuracy</b>	± 15% of tach trigger range
<b>Trigger Impedance</b>	
Low range	> 100 kΩ (typical)
High range	> 10 kΩ (typical)
<b>Minimum Trigger Pulse Width</b>	600 ns
<b>Maximum Trigger Pulse Rate</b>	800 kHz
<b>Trigger Hold Off Time</b>	
Minimum	800 ns
Maximum	52.4 ms

---

**Source Output**

---

<b>Amplitude Range</b>	± 5 Vpk
<b>Amplitude Resolution</b>	
Voltage ≥ 0.2 Vrms	2.5 mVpk
Voltage < 0.2 Vrms	0.25 mVpk
<b>Residual dc Offset (except pink noise)</b>	± 10.0 mV (typical)
<b>Output Impedance</b>	< 5Ω
<b>Maximum Loading</b>	
Current	± 20 mA peak
Capacitance	0.01 μF

---

**Sine**

---

<b>Sine Amplitude Accuracy at 1 kHz</b> Rload > 250Ω, 0.1 Vpk to 5 Vpk	± 4% (0.34 dB) of setting
<b>Sine Flatness (relative to 1 kHz)</b> 0.1V to 5 Vpk, 0 Hz to 102.4 kHz	± 1 dB
<b>Harmonic and Sub-Harmonic Distortion, and Spurious Signals</b> 0.1 Vpk to 5 Vpk sine wave	
0 to 10 kHz	< -60 dBc
10 kHz to 102.4 kHz	< -40 dBc

---

**Random Noise**

---

<b>Random Noise Flatness</b>	
Measurement span only, peak to peak error, ≥ 5,000 rms averages	
At full span	< 1.5 dBpk-pk
At less than full span	< 2 dBpk-pk (typical)

---

**Pink Noise**

---

<b>Pink Noise Flatness</b>	< 4 dBpk-pk
Measured by 1/3 octave analysis, passband only, 32 second stable average, peak to peak error	

---

**Interfaces**

---

<b>External Keyboard</b>	Compatible with PC Style 101-Key Keyboard (DIN connector) (see table 1-2 for part numbers of approved keyboards)
<b>HP-IB</b>	Conforms to the following standards: IEEE 488.1 (SH1, AH1, T6, TE0, L4, LE0, SR1, RL1, PPO, DC1, DT1, C1, C2, C3, C12, E2) IEEE 488.2-1987 Complies with SCPI 1990 Factory set address: 11
<b>Data Transfer Rate</b>	< 95 ms for a 401 point trace Measured with HP 9836A and HP Series 350 running HP BASIC (REAL 64 Format)
<b>Port 1 (RS-232)</b>	9 pin connector accessible only from optional HP Instrument BASIC

---

**Peripherals**

---

HP-IB HP-GL Plotters  
HP-IB PCL Printers  
HP-IB SS-80 External Disks

---

**General Specifications**

---

**Safety Standards** CSA Certified for Electronic Test and Measurement Equipment per Bulletin 556B

This product is designed for compliance to: UL1244, Second Edition and IEC 348, Second Edition, 1978

**EMI / RFI Standards**

FTZ 1046 (1984) - Germany

**Acoustics**

LpA < 70 dB

**Environmental Operating Restrictions**

Ambient temperature	4 to 45°C
Minimum humidity	20% RH
Maximum humidity	80% RH at 32°C
Maximum altitude	non-condensing 2300 meters (7,500 feet)

**Storage and Transport Restrictions**

Ambient temperature	-20 to 65°C
Minimum humidity	10% RH
Maximum humidity	90% RH at 40°C
Maximum altitude	non-condensing 4600 meters (15,000 feet)

*Contact Hewlett-Packard if your application requires extended environmental specifications.*

<b>Power</b>	90 Vrms to 132 Vrms (47 to 440 Hz) 198 Vrms to 264 Vrms (47 to 66 Hz) 280 VA Maximum
--------------	--

<b>Warm-Up Time</b>	15 minutes
---------------------	------------

<b>Weight</b>	22 kg (47 lb) net 27 kg (60 lb) shipping
---------------	---

<b>Dimensions</b> Excluding protrusions (handles, BNCs, feet)	Height: 8.75 in (222 mm) Width: 16.75 in (425.5 mm) Depth: 21.0 in (533 mm)
---	---

---

**Abbreviations**

---

- dBVrms = dB relative to 1 Volt rms.
- dBfs = dB relative to full scale amplitude range. Full scale is approximately 2 dB below ADC overload.
- FS or fs = Full Scale; synonymous with Input Range.
- Rds or Rs = Resistance of source or termination connected to HP 35665A's input (from high to low).
- Rcms = Resistance of source or termination connected to HP 35665A's input (from low to chassis).
- Vs = dc offset voltage applied to HP 35665A's input.
- vs = ac signal voltage applied to HP 35665A's input.
- Vpk = Peak of the ac voltage.
- Rload = Load resistance connected to HP 35665A's source.
- CF = Center frequency.
- Typical = Typical, non-warranted, performance specification included to provide general product information.
- Real time or Online = Collecting and displaying information with no dropouts or missing information.
- Zoom mode = Start frequency > 0 Hz.

**Computed Order Tracking – Option 1D0**  
**Requires 1C1 or ANA**

<b>Pulses per Revolution</b>	1/2, 1 to 2048 (integer steps)
<b>Max Order × Max RPM</b> 60	
Online (real time):	
<i>One Channel Mode:</i>	≤ 25,600 Hz
<i>Two Channel Mode:</i>	≤ 12,800 Hz
Capture Playback*:	
<i>One Channel Mode:</i>	≤ 102,400 Hz
<i>Two Channel Mode:</i>	≤ 51,200 Hz
Specified for	
5 ≤ RPM ≤ 220,000 (online)	
5 ≤ RPM ≤ 491,519 (capture playback); and number of orders	
≤ 200	
* Signals are captured online and then postprocessed in capture playback mode.	
<b>Delta Order</b>	1/128 to 1/1
<b>Resolution</b>	≤ 200
Max Order	
Delta Order	
<b>RPM Accuracy</b>	± 100 ppm
<b>Maximum RPM Ramp Rate</b>	750 RPM / second
1000 to 10,000 RPM run up, max order = 10, delta order = 0.1, RPM step = 30 (One Channel), RPM step = 60 (Two Channel)	(typical)

**Real Time Octave Analysis – Option 1D1**

**Standards:**  
Conforms to ANSI Standard  
S1.11 - 1986, Order 3, Type 1-D,  
Extended and Optional Frequency  
Ranges  
  
Conforms to IEC 651-1979 Type 0  
Impulse, and ANSI S1.4

Frequency ranges (at centers)

Online (real time):

*One Channel Mode:*

1/1 octave	0.063 Hz to 16 kHz
1/3 octave	0.080 Hz to 31.5 kHz
1/12 octave	0.0997 Hz to 12.34 kHz

*Two Channel Mode:*

1/1 octave	0.063 Hz to 8 kHz
1/3 octave	0.080 Hz to 16 kHz
1/12 octave	0.0997 Hz to 6.169 kHz

Time Capture (from full span) \*

*One Channel Mode:*

1/1 octave	0.063 Hz to 16 kHz
1/3 octave	0.080 Hz to 31.5 kHz
1/12 octave	0.0997 Hz to 49.35 kHz

*Two Channel Mode:*

1/1 octave	0.063 Hz to 16 kHz
1/3 octave	0.080 Hz to 31.5 kHz
1/12 octave	0.0997 Hz to 49.35 kHz

Except 1 to 11 octaves in 2 channel mode in full and 1/3 octave  
when the highest stop frequency is selected.

1/1, 1/3, and 1/12 octave true center frequencies related by the  
formula:

$$\frac{f(i+1)}{f(i)} = \frac{2^1}{n}; n=1, 3, \text{ or } 12;$$

Where 1000 Hz is the reference for 1/1, 1/3 octave, and 1000  
× 2<sup>(1/24)</sup> Hz is the reference for 1/12 octave. The marker returns  
the ANSI standard preferred frequencies.

\* Signals are captured online and then postprocessed in  
capture playback mode.

**1/3 Octave Update Rate**

From the Preset condition:

*One Channel Mode*

16 kHz bandwidth 12 updates/second (typical)

32 kHz bandwidth 5 updates/second (typical)

*Two Channel Mode*

(8 kHz, 16 kHz bandwidths) 8 updates/second (typical)

**1/3 Octave Dynamic Range**

2 second stable average, total power  
limited by the input noise level > 80 dB (typical) as per  
ANSI S1.11.19 for full scale  
ranges from 50 mV peak to  
31.7 V peak

**Stable Average Range**

*One Channel Mode*

Real-time bandwidth = 32 kHz 0.015625 to 512s

*Two Channel Mode* in 2× steps.

Real-time bandwidth = 16 kHz 0.03125 to 1024s

in 2× steps.

---

**Swept Sine Measurements – Option 1D2**

---

**Dynamic Range** > 130 dB (typical)  
(Input auto range on)  
100 ms integration

**Sweep Times**

51.2 Hz to 51.2 kHz span  
11 dBVrms source level

100 ms integration time	approximately 70 s (typical)
10 ms integration time	approximately 18 s (typical)
5 cycle integration time	approximately 7 s (typical)
100 cycle integration time	approximately 18 s (typical)

**Cross-Channel**

**Amplitude/Phase Accuracy**  
from preset condition  $\pm 0.04$  dB  
Ch 1 range = Ch 2 range  $\pm 0.5$  deg

---

**Arbitrary Waveform Source – Option 1D4**

---

<b>Amplitude Range</b>	$\pm 5$ Vpk
<b>Record Length</b>	1024 points (512 complex points)
<b>Delta-T Spacing</b>	Matches the measurement sample rate
<b>DAC Resolution</b>	
0.2828 Vpk to 5 Vpk	2.5 mV
< 0.2828 Vpk	0.25 mV





## Preparing the Analyzer for Use

---

### How to Use This Chapter

This chapter contains power requirements and operating environment information needed to install the HP 35665A Dynamic Signal Analyzer. Also included in this chapter are instructions for cleaning the screen and information on storage and shipment.

---

### Incoming Inspection

The HP 35665A Dynamic Signal Analyzer was carefully inspected both mechanically and electrically before shipment. It should be free of marks or scratches and, it should meet its published specifications upon receipt. Shipped with the analyzer is the power cord and the plastic transportation disk, part number HP 5061-2819.

Inspect the analyzer for physical damage incurred in transit. If the analyzer was damaged in transit, save all packing materials, file a claim with the carrier, and call your Hewlett-Packard sales and service office.

---

#### Warning



If the analyzer is mechanically damaged, the integrity of the protective earth ground may be interrupted. Do not connect the analyzer to power if it is damaged.

---

### Incoming Tests

Finish incoming inspection by testing the electrical performance of the analyzer using the operation verification or the performance tests in chapter 3, "Verifying Specifications," in this guide. The operation verification tests verify the basic operating integrity of the analyzer; these tests take about 45 minutes to complete and are a subset of the performance tests. The performance tests verify that the analyzer meets all the performance specifications; these tests take about one hour to complete.

## Power Requirements

The analyzer can operate from a single-phase ac power source supplying voltages as shown in table 2-1. With all options installed, power consumption is less than 280 VA.

The line-voltage selector switch is set at the factory to match the most commonly used line voltage of the country of destination; the appropriate fuse is also installed. To check or change either the line-voltage selector switch or the fuse, see figure 2-1, table 2-1, and the following procedures.

### Warning



Only a qualified service person, aware of the hazards involved, should measure the line voltage.

### Caution



Before applying ac line power to the analyzer, ensure the line-voltage selector switch (on the rear panel) is set for the proper line voltage and the correct line fuse is installed in the fuse holder.

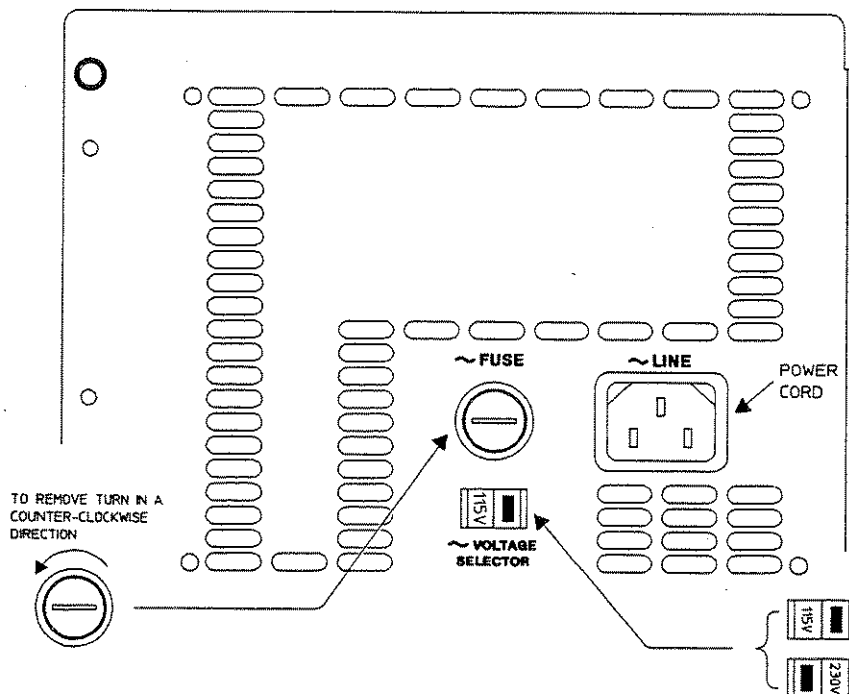

Figure 2-1. Voltage Selection and Fuse Replacement

**Table 2-1. Line Voltage and Fuse Selection**

AC Line Voltage Frequency Range		Selector Switch	HP Part Number	Fuse Type
90-132Vrms	47-440	115	2110-0056	6A 250V Fast Acting
198-264Vrms	47-66	230	2110-0003	3A 250V Fast Acting

To change the line voltage selector switch:

1. Unplug the power cord from the analyzer.
2. Slide the line voltage selector switch (see figure 2-1) to the proper voltage.

To change the fuse:

1. Unplug the power cord from the analyzer.
2. Using a small screw driver, turn the fuse holder cap counter-clockwise and remove when the fuse cap is free from the housing (see figure 2-1).
3. Pull the fuse from the fuse holder cap.
4. To reinstall, select the proper fuse (see table 2-1) and place in the fuse holder cap. Place the fuse holder cap in the housing and turn clockwise while pressing in.

### Power Cable and Grounding Requirements

On the HP-IB connector, pin 12 and pins 18 through 24 are tied to chassis ground and the HP-IB cable shield. On the Port 1 connector, pin 7 is tied to chassis ground. The instrument frame, chassis, covers, all exposed metal surfaces including the BNC connectors' outer shell are connected to chassis ground, except Channel 1 or Channel 2 when setup in a floating configuration.

---

#### Warning



**DO NOT** interrupt the HP 35665A Dynamic Signal Analyzer's protective earth ground. This action could expose the operator to potentially hazardous voltages.

---

The analyzer is equipped with a three-conductor power cord which grounds the analyzer when plugged into an appropriate receptacle. The type of power cable plug shipped with each analyzer depends on the country of destination. See figure 2-2 for the available power cables and plug configurations.

<p>United Kingdom Option 900</p>  <p>PLUG*: BS 1363A CABLE*: HP 5041-5807</p> <p>220V-5A OPERATION</p>	<p>Australia/New Zealand Option 901</p>  <p>PLUG*: NZSS 198/AS C112 CABLE*: HP 5041-5808</p> <p>220V-6A OPERATION</p>
<p>Continental Europe Option 902</p>  <p>PLUG*: CEE7-V11 CABLE*: HP 5041-5809</p> <p>220V-6A OPERATION</p>	<p>North America Option 903</p>  <p>PLUG*: NEMA 5-15P CABLE*: HP 5041-5819</p> <p>125V-10A** OPERATION</p>
<p>North America Option 904</p>  <p>PLUG*: NEMA-6-15P CABLE*: HP 5041-5806</p> <p>250V-6A** OPERATION</p>	<p>Japan Option 918</p>  <p>PLUG*: MITI 41-9692 CABLE*: HP 5041-5840</p> <p>125V-12A OPERATION</p>
<p>Switzerland Option 906</p>  <p>PLUG*: SEV 1011.1959-24507 TYPE 12 CABLE*: HP 5041-5812</p> <p>220V-6A OPERATION</p>	<p>Denmark Option 912</p>  <p>PLUG*: DHCR 107 CABLE*: HP 5041-5814</p> <p>220V-6A OPERATION</p>

Figure 2-2. Power Cables

\*The number shown for the plug is the industry identifier for the plug only, the number shown for the cable is an HP part number for a complete cable including the plug.

\*\*UL listed for use in the United States of America.

**Warning**

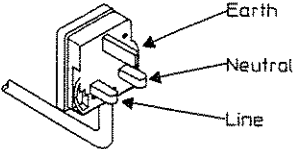
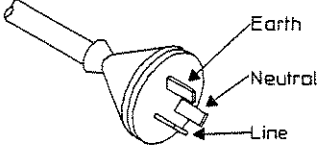
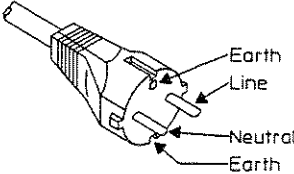
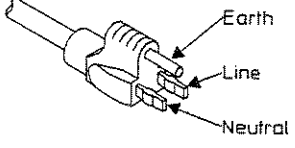
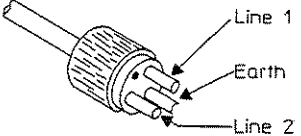
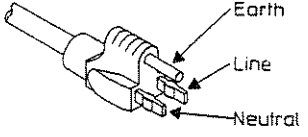
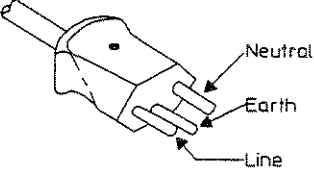
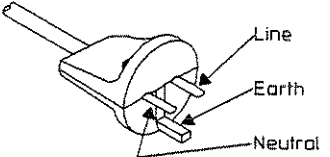

The power cable plug must be inserted into an outlet provided with a protective earth terminal. Defeating the protection of the grounded analyzer cabinet can subject the operator to lethal voltages.

---

## Operating Environment

The operating and storage environment specifications for the analyzer, are listed in chapter 1, "Introducing the HP 35665A."

---

### Warning



To prevent potential fire or shock hazard, do not expose the analyzer to rain or other excessive moisture.

---

Protect the analyzer from moisture and temperatures or temperature changes that cause condensation within the analyzer.

---

### Caution



Use of the equipment in an environment containing dirt, dust, or corrosive substances will drastically reduce the life of the disk drive and the flexible disks. The disks should be stored in a dry, static-free environment.

---

## Analyzer Cooling

Cooling air enters the analyzer through the left side and exhausts through the rear panel. Install the analyzer to allow free circulation of cooling air.

---

## Port 1 Interface Connection

The Port 1 connector on the rear panel of the analyzer is an RS-232-C serial port. Access to this port is only available through HP Instrument BASIC. This port supports the minimum number of signals used in an RS-232-C serial interface system. Use standard RS-232-C compatible cables to connect the analyzer to other devices. Total allowable transmission path length is 50 feet. For additional information, see chapter 9 in *Using HP Instrument BASIC with the HP 35665A* or chapter 9 in the *HP 35665A Service Guide*.

---

## HP-IB System Interface Connections

The analyzer is compatible with the Hewlett-Packard Interface Bus (HP-IB). The HP-IB is Hewlett-Packard's implementation of IEEE Standard 488.2. The analyzer is connected to the HP-IB by connecting an HP-IB interface cable to the connector located on the rear panel. Total allowable transmission path length is 2 meters times the number of devices or 20 meters, whichever is less. Operating distances can be extended using an HP-IB Extender.

For additional HP-IB programming information, see *HP-IB Programming with the HP 35665A*.

---

### Caution



The analyzer contains metric threaded HP-IB cable mounting studs as opposed to English threads. Use only metric threaded HP-IB cable lockscrews to secure the cable to the analyzer. Metric threaded fasteners are black, while English threaded fasteners are silver.

---

## Screen (CRT) Cleaning

The analyzer screen is covered with a plastic diffuser screen (this is not removable by the operator). Under normal operating conditions, the only cleaning required will be an occasional dusting. However, if a foreign material adheres itself to the screen, set the power switch to STANDBY (⓪), remove the power cord, dampen a soft, lint-free cloth with a mild detergent mixed in water, and carefully wipe the screen.

---

### Caution



Do not apply any water mixture directly to the screen or allow moisture to go behind the front panel. Moisture behind the front panel will severely damage the instrument.

To prevent damage to the screen, do not use cleaning solutions other than the above.

---

## Installation

The analyzer is shipped with plastic feet in place, ready for use as a portable bench analyzer. The plastic feet are shaped to make full-width modular instruments self-align when they are stacked. To install the analyzer in an equipment cabinet, follow the instructions shipped with the Rack Mount Kit, option 1CM.

### Installing the Optional Keyboard

If you have the PC Style Keyboard, option 1CL, set the power switch to STANDBY (⏻), then connect the keyboard to the analyzer using the keyboard cable (see figure 2-3). Make sure to align the round plug on the cable with the connector on the analyzer's front panel.

---

#### Note



On some versions of the HP 35665A, the keyboard connector is on the analyzer's rear panel.

---

#### Caution



Do not connect or disconnect the keyboard cable with the line power turned ON (I). Connecting or disconnecting the keyboard while power is applied may damage the keyboard or the analyzer.

Use only the HP approved keyboard for this product. HP does not warrant damage or performance loss caused by a non-HP approved keyboard. Currently, approved Hewlett-Packard keyboards are as follows:

- U.S. ASCII (C1405A #ABA)
  - U.K. English (C1405A #ABU)
  - German (C1405A #ABD)
  - French (C1405A #ABF)
  - Italian (C1405A #ABZ)
  - Spanish (C1405A #ABE)
  - Swedish (C1405A #ABS)
-

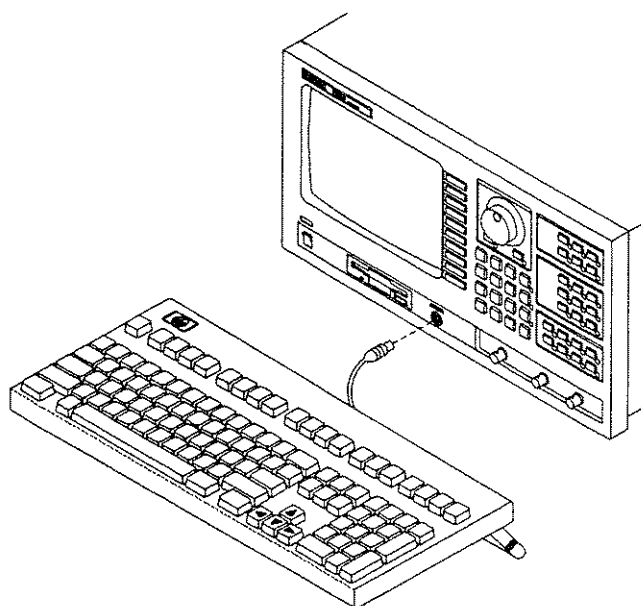

**Figure 2-3. Connecting the Keyboard**

The keyboard remains active *even when the analyzer is not in alpha entry mode*. This means that you can operate the analyzer using the external keyboard rather than the front panel. Pressing the appropriate keyboard key does the same thing as pressing a hardkey or a softkey on the analyzer's front panel.

In addition to the U.S. English keyboard, the HP 35665A Dynamic Signal Analyzer supports U.K. English, German, French, Italian, Spanish, and Swedish/Finnish. To configure your analyzer for a keyboard other than U.S. English, press [ **System Utility** ] [ **KEYBOARD SETUP** ]. Then press the appropriate softkey to select the language. Configuring your analyzer to use a different keyboard only ensures that the analyzer recognizes the proper keys for that particular keyboard. Configuring your analyzer to use another keyboard *does not* localize the on-screen annotation or the analyzer's online HELP facility.

---

## Turning on the HP 35665A

First, apply proper line power to the analyzer, then press the rocker-switch in the lower left-hand corner of the analyzer to ON ( I ). The analyzer requires about 40 seconds to test memory and self-calibrate.

For measurement specific information, or other operating information, see the *HP 35665A Operator's Guide* or other appropriate manual. See the documentation map included with the analyzer for information on which document contains the information you need.



---

## Need Assistance?

If you need assistance, contact your nearest Hewlett-Packard sales and service office listed in the HP Catalog, or contact your nearest regional office listed at the back of this guide. If you are contacting Hewlett-Packard about a problem with your HP 35665A Dynamic Signal Analyzer, please provide the following information:

- Model number: HP 35665A
- Serial number:
- Options:
- Firmware version (see page 1-3):
- Date the problem was first encountered:
- Circumstances in which the problem was encountered:
- Can you reproduce the problem?
- What effect does this problem have on you?

---

## Storage and Shipment

### Storage

Store the analyzer in a clean, dry, and static free environment. For other requirements, see environmental specifications in chapter 1, "Introducing the HP 35665A."

### Shipment

---

#### Caution



When transporting the analyzer, insert the plastic transportation disk, part number HP 5061-2819, into the disk drive to prevent damage.

---

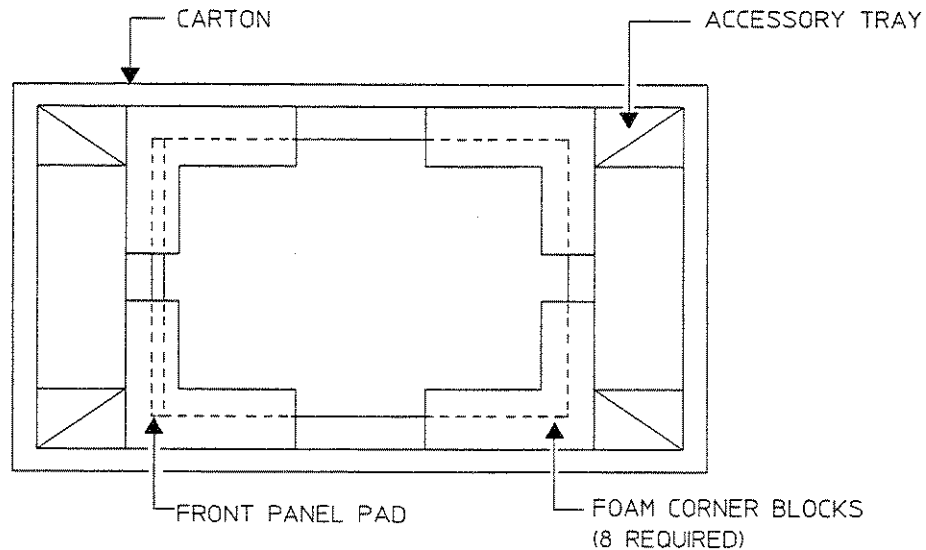

**Figure 2-4. Repacking for Shipment**

- Containers and materials identical to those used in factory packaging are available through Hewlett-Packard offices, see figure 2-4. If the analyzer is being returned to Hewlett-Packard for service, attach a tag describing the type of service required, the return address, model number, and full serial number. Also, mark the container **FRAGILE** to ensure careful handling. In any correspondence, refer to the analyzer by model number and full serial number.
- If it is necessary to package the analyzer in a container other than original packaging observe the following (use of other packaging is not recommended):
  - Protect the front panel with cardboard and wrap the analyzer in heavy paper or anti-static plastic.
  - Use a double-wall carton made of at least 350-pound test material and cushion the analyzer to prevent damage.
  - Identify the shipment as above and mark **FRAGILE**.

---

**Caution**



Do not use styrene pellets in any shape as packing material for the analyzer. The pellets do not adequately cushion the analyzer and do not prevent the analyzer from shifting in the carton. In addition, the pellets create static electricity which can damage electronic components.

---

## Verifying Specifications

---

### How to Use This Chapter

This chapter tells you how to use the *Semiautomated Performance Test Disk*. The performance test disk contains a program that semiautomates the operation verification tests and performance tests. After you review this chapter, follow the directions in “How to Load the Program” then continue with one of the following:

- “How to Run the Program in Semiautomated Mode”
- “How to Run the Program Without a Printer”
- “How to Run the Program in Manual Mode”

---

### Overview

The *Semiautomated Performance Test Disk* contains a program (ITM\_35665A) and two procedure files (OP\_VERIFY and PERFORMAN). ITM\_35665A is the test manager program. OP\_VERIFY is the operation verification procedure files and PERFORMAN is performance test procedure files. The procedure files contain an ordered list of tests, and each test contains one or more measurements. Since ITM\_35665A reads the procedure files, the disk must remain in the disk drive during testing.

There are two types of keys on the HP 35665A Dynamic Signal Analyzer — hardkeys and softkeys. Hardkeys are front-panel buttons whose functions are always the same. Hardkeys have a label printed directly on the key itself. Throughout this guide, they are printed like this: [ **Hardkey** ] Softkeys are keys whose functions change with the analyzer’s current menu selection. A softkey’s function is indicated by a video label to the left of the key (on the edge of the analyzer’s screen). Throughout this guide, softkeys are printed like this: [ SOFTKEY ]

If you do not have a keyboard connected to the analyzer, use the numeric key pad and the alpha keys when the program prompts you to type in information. See the analyzer’s help text for a description of the alpha keys.

If a test fails, contact your local Hewlett-Packard sales and service office or have a qualified service technician see chapter 4, “Troubleshooting the HP 35665A,” in the *HP 35665A Service Guide*.

### **Features of the Program**

- The program can automatically create a printout similar to the test records at the back of this chapter.
- The program can beep when equipment connections need to be changed.
- The program can start the test sequence at any test in the operation verification or performance test list.
- The program can stop after each measurement or alternatively, only if a failure occurs.
- The program can be run in manual mode.

---

## Test Duration

The operation verification tests require approximately 45 minutes to complete in semiautomated mode. The performance tests require approximately one hour to complete in semiautomated mode.

---

### Caution



Before applying line power to the analyzer or testing its electrical performance, see chapter 2, “Preparing the Analyzer for Use.”

---

---

## Calibration Cycle

To verify the HP 35665A Dynamic Signal Analyzer is meeting its published specifications, do the performance tests every 12 months.

---

## Recommended Test Equipment

The equipment needed for operation verification and performance tests is listed in table 1-3. Other equipment may be substituted for the recommended model if it meets or exceeds the listed critical specifications.

Also, if you want the test record to be automatically printed, you need an HP-IB printer. If you do not have an HP-IB printer you must record the results of each test in the test records. These test records may be reproduced without written permission of Hewlett-Packard.

---

### Note



If you want the printer to automatically leave top and bottom margins on every page, enable perforation skip mode (see your printer's manual for directions).

---

## Program Controlled Test Equipment

This program automatically controls the instruments in table 3-1 using HP-IB commands. If you use a test instrument other than those shown in table 3-1, the program prompts you to set the instrument state during testing.

**Table 3-1. Program Controlled Test Equipment**

Test Equipment	Program Controlled Model
AC Calibrator	Fluke 5700A Alternative: Fluke 5200A Datron 4200, 4707, 4708
Frequency Synthesizer	HP 3326A Alternative: (2) HP 3325A (2) HP 3325B
Digital Multimeter	HP 3458A Alternative: HP 3455A HP 3456A HP 3478A

**Measurement Uncertainty**

A table starting on page 3-49 lists the measurement uncertainty and ratio for each performance test using the recommended test equipment. The ratios listed for the recommended test equipment meet or exceed the measurement uncertainty ratio required by U.S. MIL-STD-45662A. The table also provides a place to record the measurement uncertainty and ratio for each performance test using equipment other than the recommended test equipment. The table may be reproduced without written permission of Hewlett-Packard.

## Operation Verification and Performance Tests

The operation verification tests give a high confidence level (>90%) that the HP 35665A Dynamic Signal Analyzer is operating properly and within specifications. The operation verification tests are a subset of the performance tests. The operation verification tests should be used for incoming and after-repair inspections. The performance tests provide the highest level of confidence and are used to verify that the HP 35665A Dynamic Signal Analyzer conforms to its published specifications. Some repairs require a performance test to be done after the repair (see chapter 6, "Replacing Assemblies" in the *HP 35665A Service Guide* for this information). The following table lists the operation verification and performance tests.

**Table 3-2. Operation Verification and Performance Test List**

Operation Verification Tests	Performance Tests
Self Test	Self Test
DC Offset	DC Offset
Amplitude Accuracy	Amplitude Accuracy
Flatness	Flatness
Amp_Phase Match	Amplitude Linearity
Frequency Accuracy	Amp_Phase Match
Single Ch Phase Accuracy	Anti-Alias Filter
Spurious Signals	Frequency Accuracy
Noise	Input Coupling
Source Amplitude Accuracy	Single Ch Phase Accuracy
Source Flatness	Input Resistance
Source Distortion	Input Capacitance
	Harmonic Distortion
	Intermodulation Distortion
	Spurious Signals
	Noise
	Cross Talk
	Source Amplitude Accuracy
	Source Flatness
	Source Distortion
	Source Output Resistance



## Specifications and Performance Tests

The following table lists specifications and the performance test or tests that verify each specification.

**Table 3-3. Specifications and Performance Tests**

Specification	Performance Test
Frequency Accuracy	Frequency Accuracy
Phase Single Channel FFT Accuracy	Single Ch Phase Accuracy
Dual Channel FFT Cross-Channel Gain Accuracy FFT Cross-Channel Phase Accuracy	Amp_Phase Match Amp_Phase Match
FFT Dynamic Range Baseband Mode Alias Responses Harmonic Distortion Intermodulation Distortion Spurious and Residual Responses	Anti-Alias Filter Harmonic Distortion Intermodulation Distortion Spurious Signals
Amplitude and Inputs Residual dc Response FFT Full Scale Accuracy at 1 kHz FFT Full Scale Flatness FFT Amplitude Linearity at 1 kHz	DC Offset Amplitude Accuracy Flatness Amplitude Linearity
Input Noise Input Noise Level	Noise
Input Characteristics Coupling Cross Talk Input Impedance Input Impedance	Input Coupling Cross Talk Input Resistance Input Capacitance
Source Output Output Impedance	Source Output Resistance
Sine Sine Amplitude Accuracy at 1 kHz Sine Flatness Harmonic and Sub-Harmonic Distortion, and Spurious Signals	Source Amplitude Accuracy Source Flatness Source Distortion

---

## How to Load the Program

1. Set the HP 35665A Dynamic Signal Analyzer's power switch to STANDBY (⓪), then connect the analyzer, test instruments, and printer using HP-IB cables.
2. If you have the PC Style Keyboard, option 1CL, connect the keyboard to the analyzer using the keyboard cable (see "Installing the Optional Keyboard" in chapter 2).
3. Insert the Semiautomated Performance Test Disk into the analyzer's disk drive, then set the power switch to ON (I).
4. After the analyzer finishes its power-up calibration routine, press the following keys:
  - [ Local/HP-IB ]
  - [ SYSTEM CONTROLLR ]
  - [ System Utility ]
  - [ MEMORY USAGE ]
  - [ REMOVE WATERFALL ]
  - [ CONFIRM REMOVE ]
  - [ RETURN ]
  - [ SERVICE TESTS ]
  - [ PERFRMANC TEST ]

---

### Note



Analyzers without the additional memory option (ANA or 1C1) will display the message "out of memory" after the program is loaded. This is normal for analyzers with standard memory and will not cause problems running the program.

---

5. Now go to one of the following procedures to continue:
  - "How to Run the Program in Semiautomated Mode"
  - "How to Run the Program Without a Printer"
  - "How to Run the Program in Manual Mode"

---

## How to Run the Program in Semiautomated Mode

---

**Note**

You must have an HP-IB printer connected to your system to run the program in semiautomated mode. If you do not have a printer, see “How to Run the Program Without a Printer” later in this chapter.

For information about the program’s softkeys, see “Softkey Descriptions” later in this chapter.

---

1. Press the following keys and when the program prompts you, type in the information for the title page of the test record and press [ ENTER ]:

- [ TITLE PAGE ]
- [ TEST FACILITY ]
- [ FACILITY ADDRESS ]
- [ TESTED BY ]
- [ REPORT NUMBER ]
- [ CUSTOMER ]
- [ MORE ]
- [ TEMP ]
- [ HUMIDITY ]
- [ LINE FREQUENCY ]
- [ RETURN ]

2. Press the following keys and when the program prompts you, type in the equipment configuration information:

---

**Note**

Use the following to determine HP-IB addresses:

$100 \times (\text{interface select code}) + (\text{primary address})$

The interface select code for the test equipment and printer is 7 (for example, if the primary address is 8, the HP-IB address is 708).

---

---

**Note**



When entering the calibration due date, only four characters are displayed on the screen. However, you can enter up to nine characters and they will be printed.

---

[ EQUIP CONFIG ]  
[ AC CALIBRATO ]  
[ SYNTH. 1 ]  
[ SYNTH. 2 ] (If needed)  
[ LOW-D OSCILLATO ] (If needed)  
[ MULTIMETER ]  
[ RETURN ]

3. Press the following keys and type in the printer address when the program prompts you:

[ TEST CONFIG ]  
[ PRINTER ADDRESS ]  
[ PROCEDURE ]  
[ OP\_VERIFY ] or [ PERFORMAN ]  
[ STOP AFTER ]  
[ LIMIT FAILURE ] or [ NONE ]  
[ RETURN ]

4. Press the following keys to start the test:

[ START TESTING ]  
[ START BEGINNING ]

---

**Note**



When you select [ START BEGINNING ], the data is written to a file on the disk and printed only after all tests are done. When you select [ START MIDDLE ] or [ ONE TEST ], the data is printed immediately after each measurement.

---

5. Now follow the directions on the display.

---

**Warning**

During the test, the program prompts you to change the test equipment connections. Always turn the ac calibrator output to OFF or STANDBY before changing test equipment connections. The ac calibrator can produce output voltages that could result in injury or death to personnel.

---

---

**Note**

The directions on the display briefly tell you how to connect test equipment. For a description of each test and detailed illustrations of equipment setup, see "Test Descriptions and Equipment Setup."

If you want to pause the program and return the HP 35665A Dynamic Signal Analyzer to front panel control, press [ BASIC ]. To continue the program, press [ BASIC ] [ DISPLAY SETUP ] [ LOWER ] [ RETURN ] [ CONTINUE ]. If you changed any instrument setup states, press [ RESTART TEST ] instead of [ CONTINUE ] to ensure accurate measurement results.

---

---

## How to Run the Program Without a Printer

1. Write in the information needed on the title page of the "Performance Test Record" or the "Operation Verification Test Record" (located near the back of this chapter).
2. Press the following keys and when the program prompts you, type in the model number and HP-IB address:

---

### Note



Use the following to determine HP-IB addresses:

$100 \times (\text{interface select code}) + (\text{primary address})$

The interface select code for the test equipment is 7 (for example, if the primary address is 8, the HP-IB address is 708).

---

[ EQUIP CONFIG ]  
[ AC CALIBRATO ]  
[ SYNTH. 1 ]  
[ SYNTH. 2 ] (If needed)  
[ LOW-D OSCILLATO ] (If needed)  
[ MULTIMETER ]  
[ RETURN ]

3. Press the following keys:

[ TEST CONFIG ]  
[ PROCEDURE ]  
[ OP\_VERIFY ] or [ PERFORMAN ]  
[ STOP AFTER ]  
[ EACH MEASUREMENT ]  
[ RETURN ]

4. Press the following keys to start the test:

[ START TESTING ]  
[ START BEGINNING ]

5. Now follow the directions on the display and record every measurement result in the "Performance Test Record" or the "Operation Verification Test Record."

---

**Warning**

During the test, the program prompts you to change the test equipment connections. Always turn the ac calibrator output to **OFF** or **STANDBY** before changing test equipment connections. The ac calibrator can produce output voltages that could result in injury or death to personnel.

---

---

**Note**

The directions on the display briefly tell you how to connect test equipment. For a description of each test and detailed illustrations of equipment setup, see "Test Descriptions and Equipment Setup."

If you want to pause the program and return the HP 35665A Dynamic Signal Analyzer to front panel control, press [ **BASIC** ]. To continue the program, press [ **BASIC** ] [ **DISPLAY SETUP** ] [ **LOWER** ] [ **RETURN** ] [ **CONTINUE** ]. If you changed any instrument setup states, press [ **RESTART TEST** ] instead of [ **CONTINUE** ] to ensure accurate measurement results.

---

---

## How to Run the Program in Manual Mode

---

### Note



Use this procedure if you want to run the program in manual mode. You will be prompted to setup all test equipment and you can check the analyzer's setup state after each measurement.

---

1. Press the following keys and when the program prompts you, set all HP-IB addresses to 0:

[ EQUIP CONFIG ]  
[ AC CALIBRATO ]  
[ SYNTH. 1 ]  
[ SYNTH. 2 ] (If needed)  
[ LOW-D OSCILLATO ] (If needed)  
[ MULTIMETER ]  
[ RETURN ]

2. Press the following keys:

[ TEST CONFIG ]  
[ PROCEDURE ]  
[ OP\_VERIFY ] or [ PERFORMAN ]  
[ STOP AFTER ]  
[ EACH MEASUREMENT ]  
[ RETURN ]

3. Press the following keys to start the test:

[ START TESTING ]  
[ START BEGINNING ]

4. Now follow the directions on the display and after every measurement do the following:

- a. Record the measurement result in the "Performance Test Record" or the "Operation Verification Test Record."
- b. If you want to view the analyzer's setup state, press [ **BASIC** ] [ **Disp Format** ] [ MEASURMNT STATE ] or [ INPUT STATE ]. To continue the program, press [ **BASIC** ] [ DISPLAY SETUP ] [ LOWER ] [ RETURN ] [ CONTINUE ].

---

### Note



If you changed any instrument setup states, press [ **RESTART TEST** ] instead of [ **CONTINUE** ] to ensure accurate measurement results.

---



---

**Warning**

During the test, the program prompts you to change the test equipment connections. Always turn the ac calibrator output to OFF or STANDBY before changing test equipment connections. The ac calibrator can produce output voltages that could result in injury or death to personnel.

---

---

**Note**

The directions on the display briefly tell you how to connect test equipment. For a description of each test and detailed illustrations of equipment setup, see “Test Descriptions and Equipment Setup.”

---

## Tests Requiring Equipment Connection Changes

The following tables show which tests require you to change the equipment connections and the page the test setup is illustrated on. The tests are listed in the order they occur.

**Table 3-4. Setup Changes for Operation Verification**

<b>Page Number</b>	<b>Test Name</b>	<b>New Setup</b>
3-18	Self Test	yes
3-19	DC Offset	yes
3-20	Amplitude Accuracy	yes
3-21	Flatness	<b>NO</b>
3-23	Amp_Phase Match	yes
3-25	Frequency Accuracy	yes
3-27	Single Ch Phase Accuracy	yes
3-35	Spurious Signals	yes
3-36	Noise	<b>NO</b>
3-39	Source Amplitude Accuracy	yes
3-40	Source Flatness	yes
3-41	Source Distortion	<b>NO</b>

**Table 3-5. Setup Changes for Performance Tests**

<b>Page Number</b>	<b>Test Name</b>	<b>New Setup</b>
3-18	Self Test	yes
3-19	DC Offset	yes
3-20	Amplitude Accuracy	yes
3-21	Flatness	<b>NO</b>
3-22	Amplitude Linearity	<b>NO</b>
3-23	Amp_Phase Match	yes
3-24	Anti-Alias Filter	yes
3-25	Frequency Accuracy	<b>NO</b>
3-26	Input Coupling	<b>NO</b>
3-27	Single Ch Phase Accuracy	yes
3-28	Input Resistance	yes
3-29	Input Capacitance	yes
3-32	Harmonic Distortion	yes
3-33	Intermodulation Distortion	†
3-35	Spurious Signals	yes
3-36	Noise	<b>NO</b>
3-37	Cross Talk	yes
3-39	Source Amplitude Accuracy	yes
3-40	Source Flatness	yes
3-41	Source Distortion	<b>NO</b>
3-42	Source Output Resistance	yes

† Depends on the equipment you use.

---

## Test Descriptions and Equipment Setup

### Self Test

**Operation Verification – Yes**

For Operation Verification, this test is the same as the Performance Test.

The self test checks the measurement hardware in the HP 35665A. No performance tests should be attempted until the analyzer passes this test. The self test takes approximately one minute to complete, and requires no external equipment.

### DC Offset

**Operation Verification – Yes**  
For Operation Verification, this test is the same as the Performance Test.

This test measures the level of residual dc offset generated within the HP 35665A.

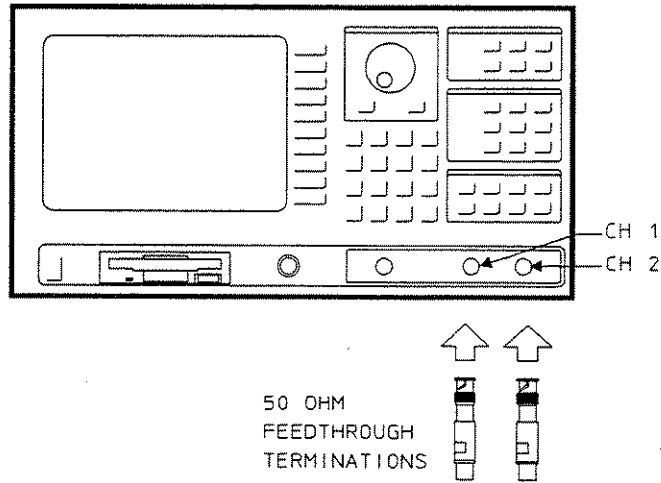

**Figure 3-1. DC Offset Test Setup**

## Amplitude Accuracy

### Operation Verification – Yes

For Operation Verification, this test checks fewer amplitudes than the Performance Test.

This test determines amplitude accuracy for both channels of the HP 35665A. Using an ac calibrator, a signal with an exact amplitude is connected to both channels and measured. The amplitude of each channel is then compared to specifications.

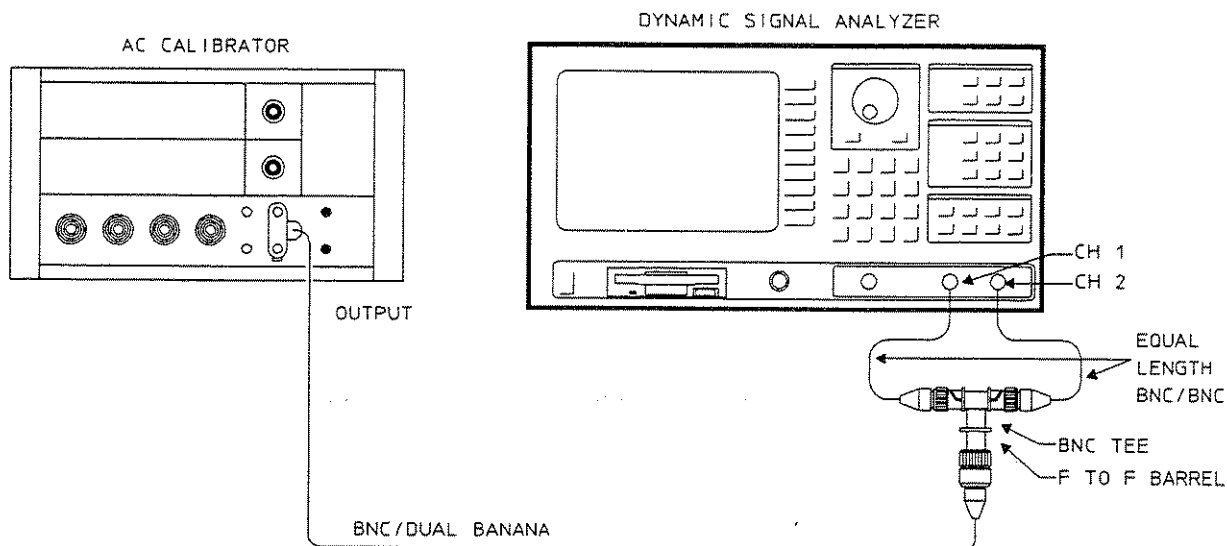
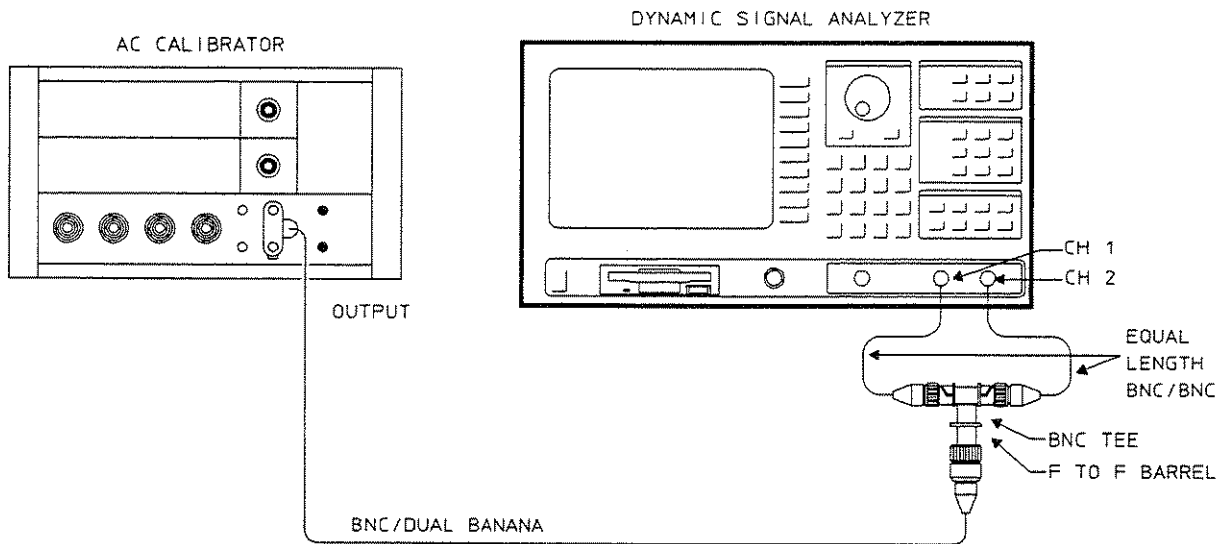

Figure 3-2. Amplitude Accuracy Test Setup

**Flatness**

**Operation Verification – Yes**  
 For Operation Verification, this test is the same as the Performance Test.

This test determines flatness for both channels of the HP 35665A. Using an ac calibrator, a signal with an exact amplitude is connected to both channels and measured. The amplitude of each channel is then compared to specifications.



**Figure 3-3. Flatness Test Setup**

## Amplitude Linearity

### Operation Verification – No

This test is not required for Operation Verification.

This test determines the amplitude linearity for both channels of the HP 35665A. Using an ac calibrator, a signal with an exact amplitude is connected to both channels and measured. The amplitude measured is then compared to specifications.

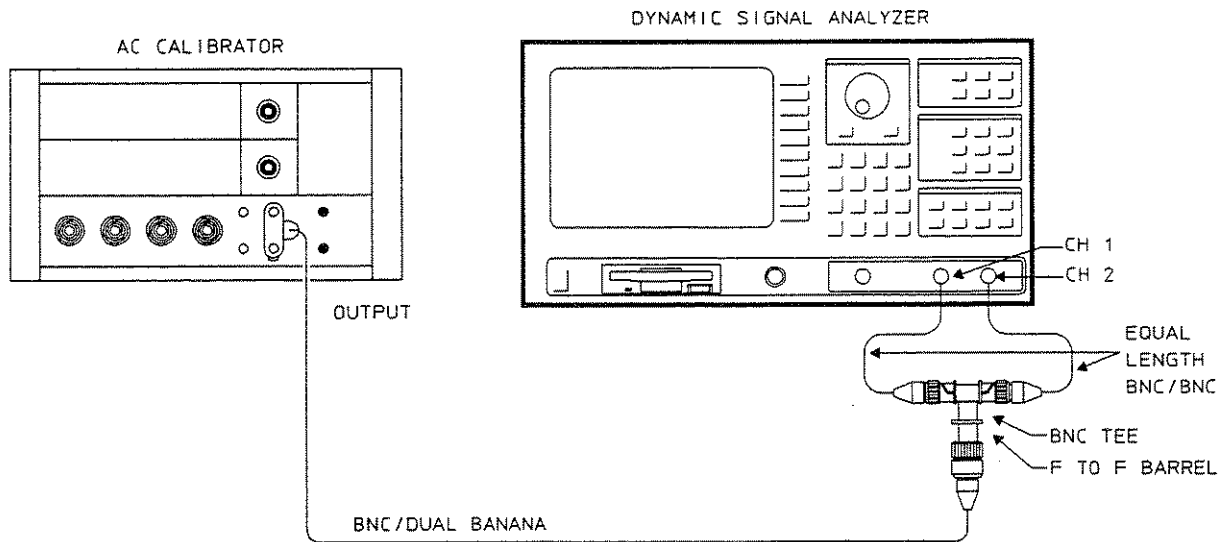

Figure 3-4. Amplitude Linearity Test Setup



### Amp\_Phase Match (Amplitude and Phase Match)

**Operation Verification – Yes**  
 For Operation Verification, this test is the same as the Performance Test.

This test measures the amplitude and phase between channels 1 and 2. An identical signal is connected to both channels (using the HP 35665A's source) and measured to verify that the amplitude and phase are approximately the same for both channels.

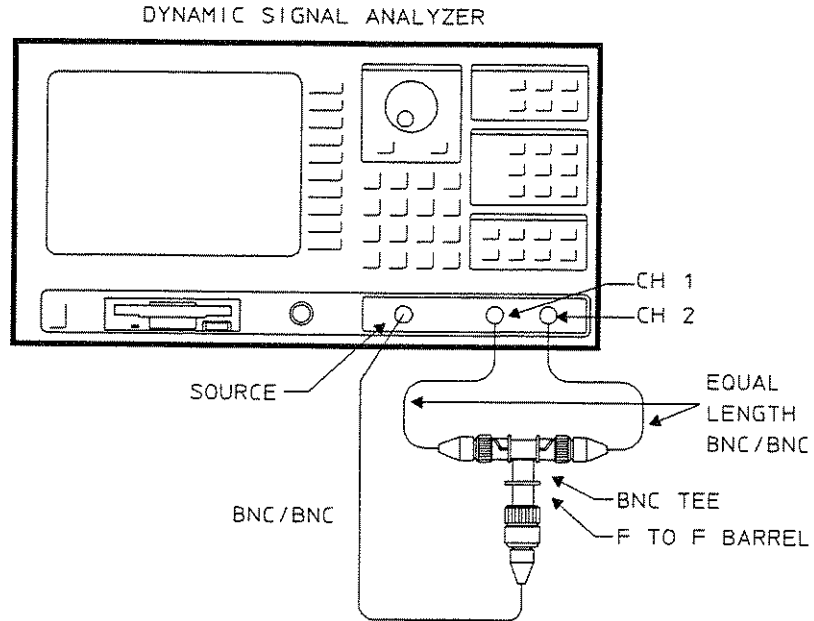

**Figure 3-5. Amplitude Phase Match Test Setup**

## Anti-Alias Filter

### Operation Verification – No

This test is not required for Operation Verification.

This test measures the ability of the 50 kHz and 100 kHz low pass anti-alias filters to reject frequencies caused by aliasing. Alias frequencies occur when the difference of the input signal frequency and the HP 35665A's sample rate both fall within the frequency range of interest. Using a frequency synthesizer, a signal known to cause an alias frequency is connected to the HP 35665A. The HP 35665A then measures the alias frequency to determine how well the alias frequency was rejected.

### Note



The HP 35665A may produce some spurious signals in the 0 to 100 kHz span. Ignore signals at frequencies other than those listed in the table when performing this test.

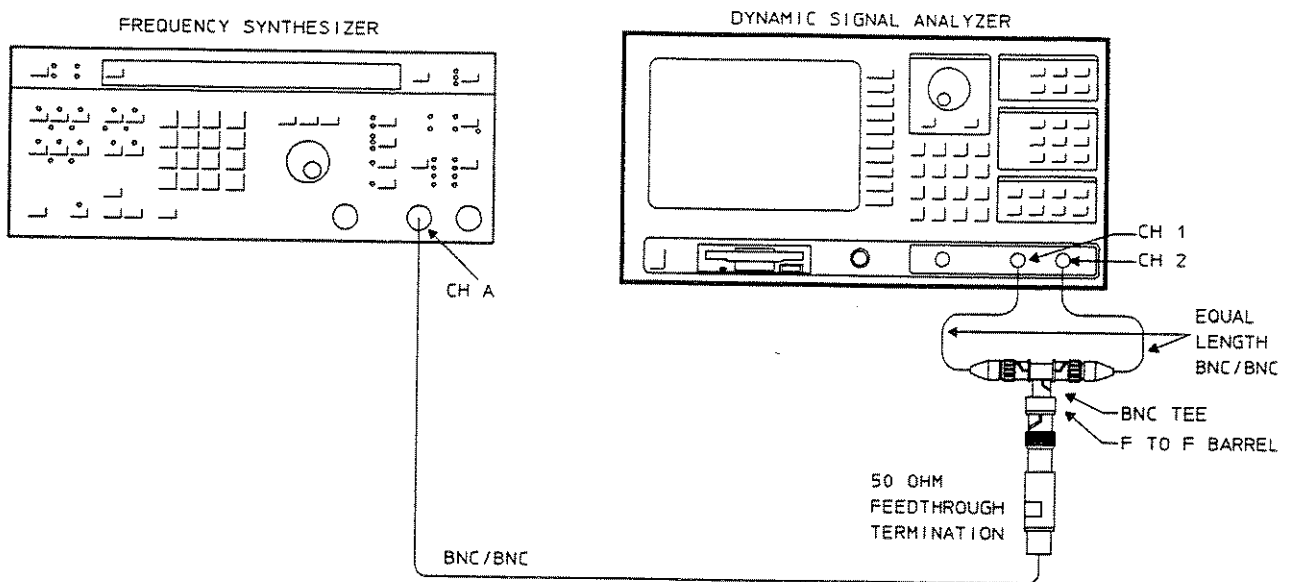
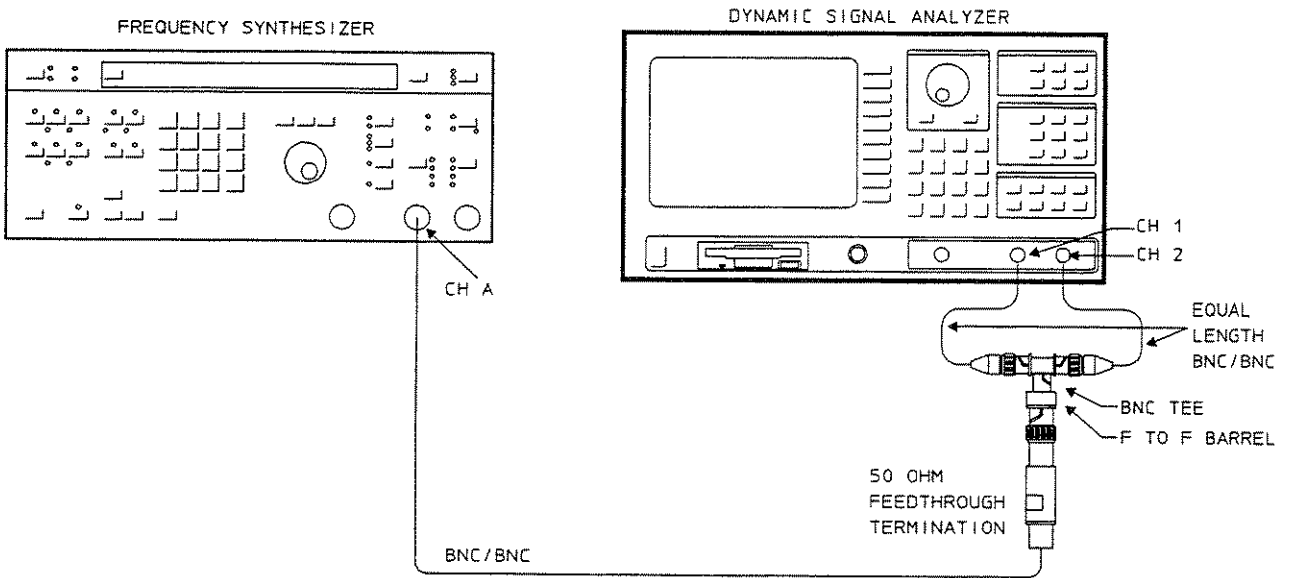

Figure 3-6. Anti-Alias Filter Test Setup

### Frequency Accuracy

**Operation Verification – Yes**  
For Operation Verification, this test is the same as the Performance Test.

This test uses a frequency synthesizer to measure the frequency accuracy of the HP 35665A.



**Figure 3-7. Frequency Accuracy Test Setup**

## Input Coupling

### Operation Verification – No

This test is not required for Operation Verification.

This test measures the input coupling insertion loss (caused by ac coupling capacitors) of the HP 35665A. The amplitude of a 1 Hz signal is measured in both ac and dc coupled modes and the values are used to determine insertion loss.

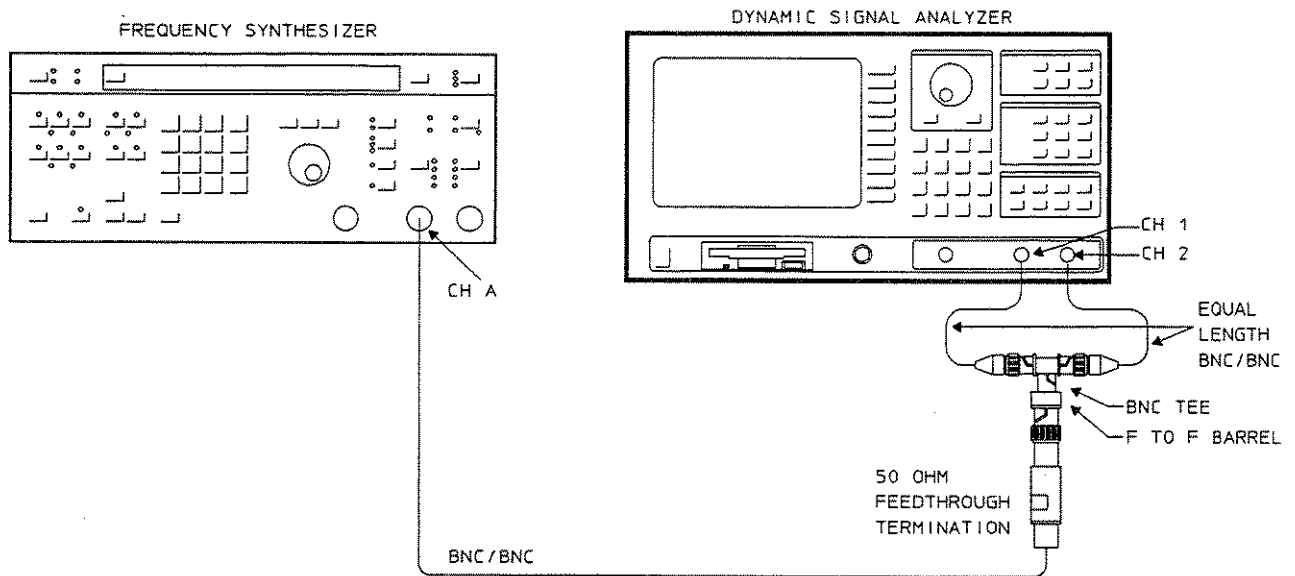
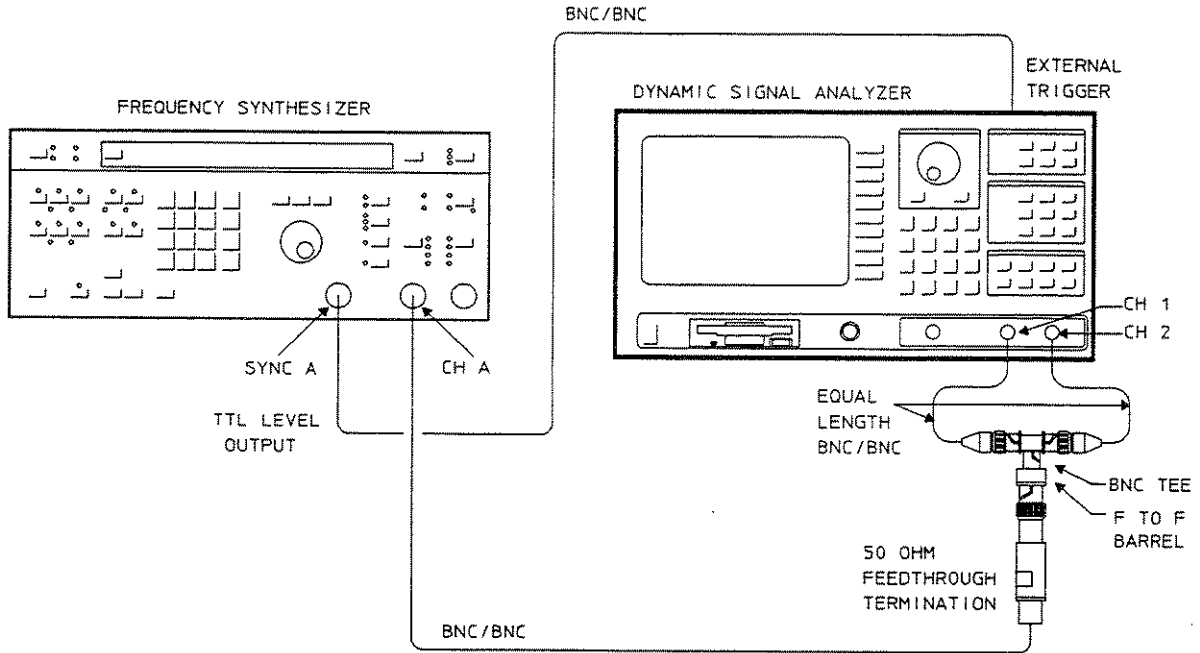

Figure 3-8. Input Coupling Test Setup

### Single Channel Phase Accuracy

**Operation Verification – Yes**  
 For Operation Verification, this test is the same as the Performance Test.

This test measures the phase accuracy of the HP 35665A relative to the phase of a trigger signal. Using a frequency synthesizer, an identical square wave is connected to both channels and a synchronized TTL level signal is connected to the trigger input. The phase between the trigger and each channel is then measured and compared to the specification.

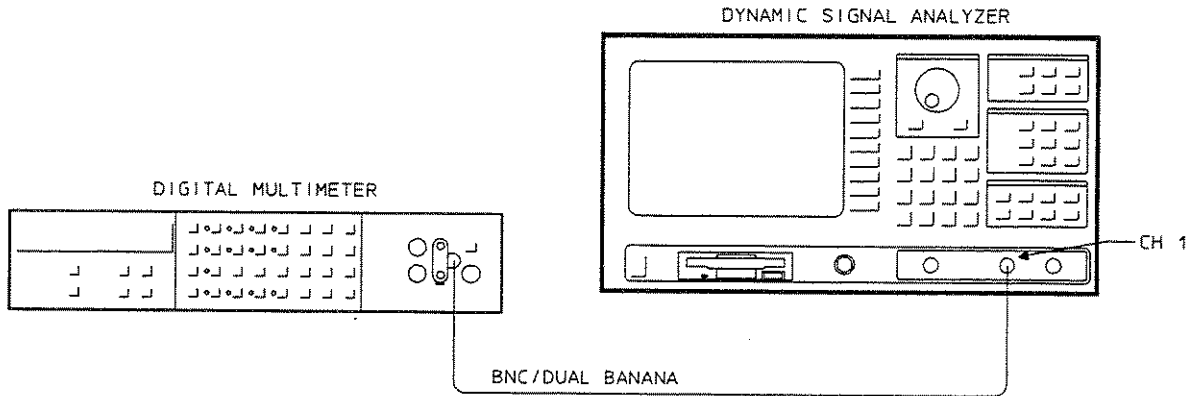

**Figure 3-9. Single Channel Phase Accuracy Test Setup**

## Input Resistance

**Operation Verification – No**  
This test is not required for Operation Verification.

This test measures the input resistance for each channel of the HP 35665A. The input resistance is measured directly using a digital multimeter.



**Figure 3-10. Input Resistance Test Setup #1**

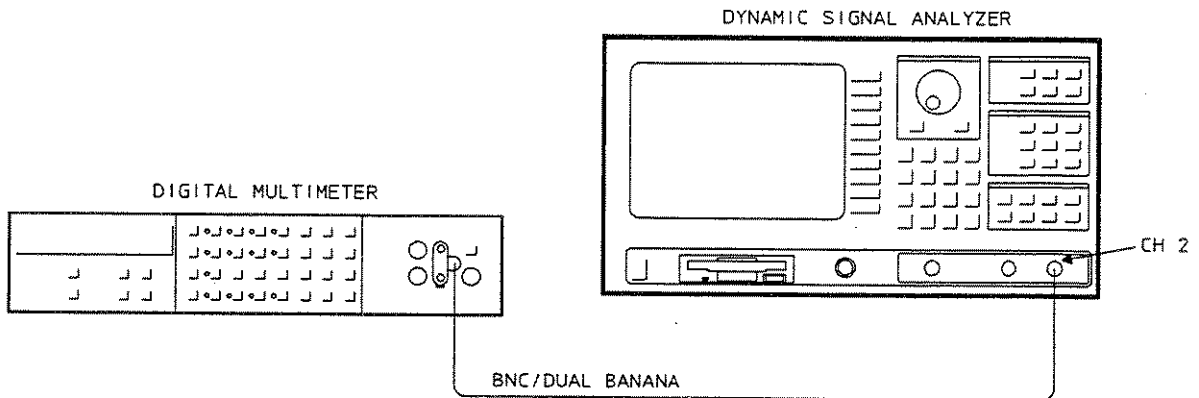

**Figure 3-11. Input Resistance Test Setup #2**

### Input Capacitance

**Operation Verification – No**  
This test is not required for Operation Verification.

This test measures the input capacitance for each channel of the HP 35665A. The capacitance is measured using a frequency synthesizer and a 100 kΩ resistor. The capacitance is then determined using the following formula.

$$C(\text{pf}) = (C\_factor \times \text{SQRT} ((V_{in}^2/V_c^2) - 1.21)) \times 1.0^{12}$$

Where  $C\_factor = 1.59^{-11}$  at 100 kHz or  $C\_factor = 3.18^{-11}$  at 50 kHz.

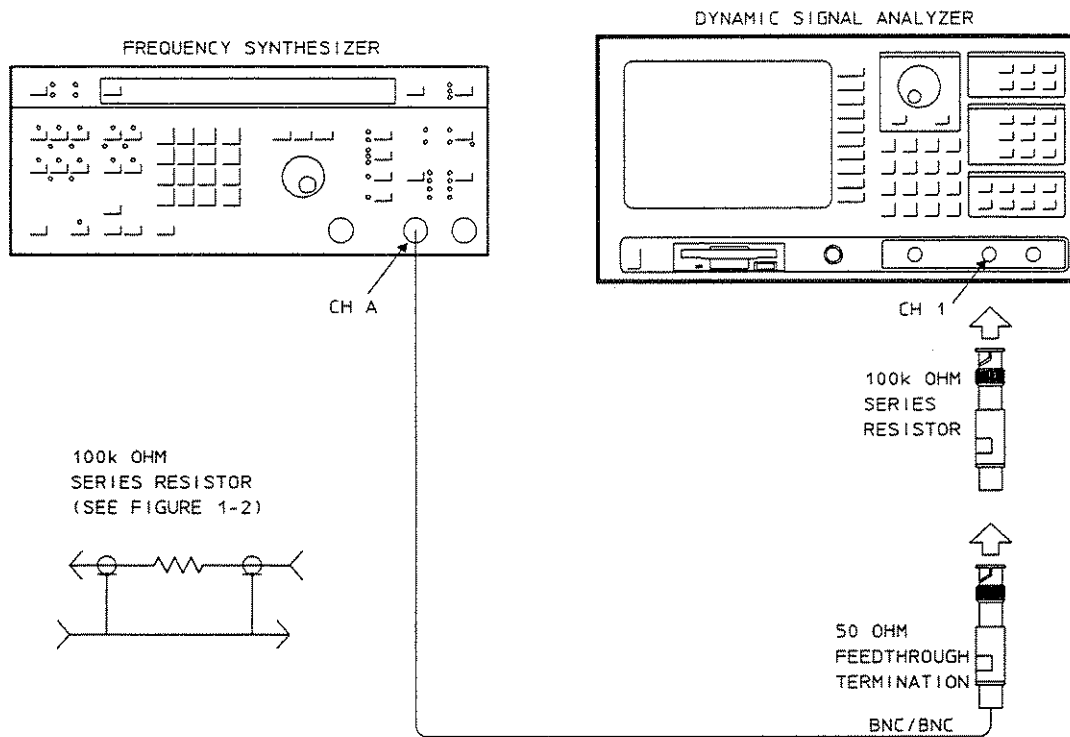

**Figure 3-12. Input Capacitance Test Setup #1**

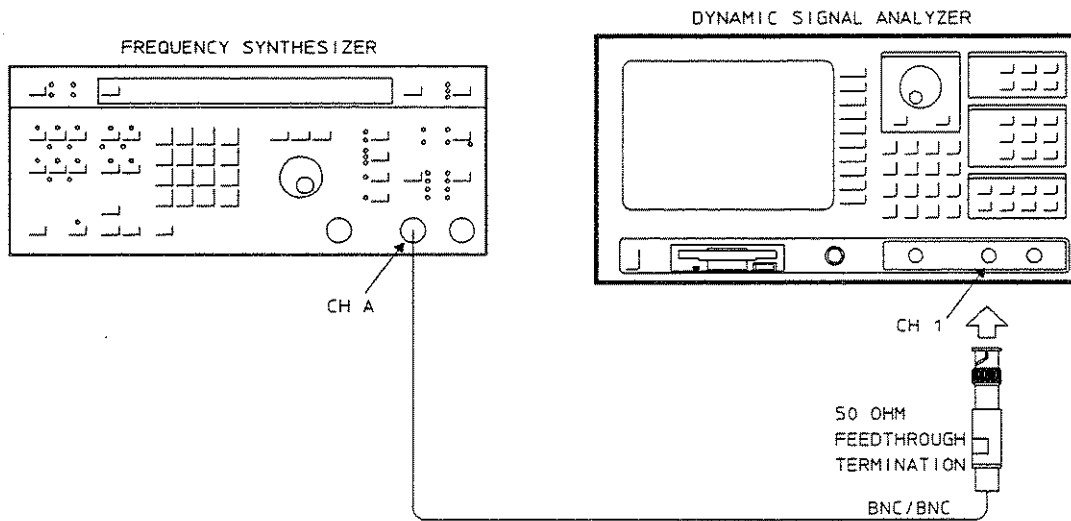

Figure 3-13. Input Capacitance Test Setup #2

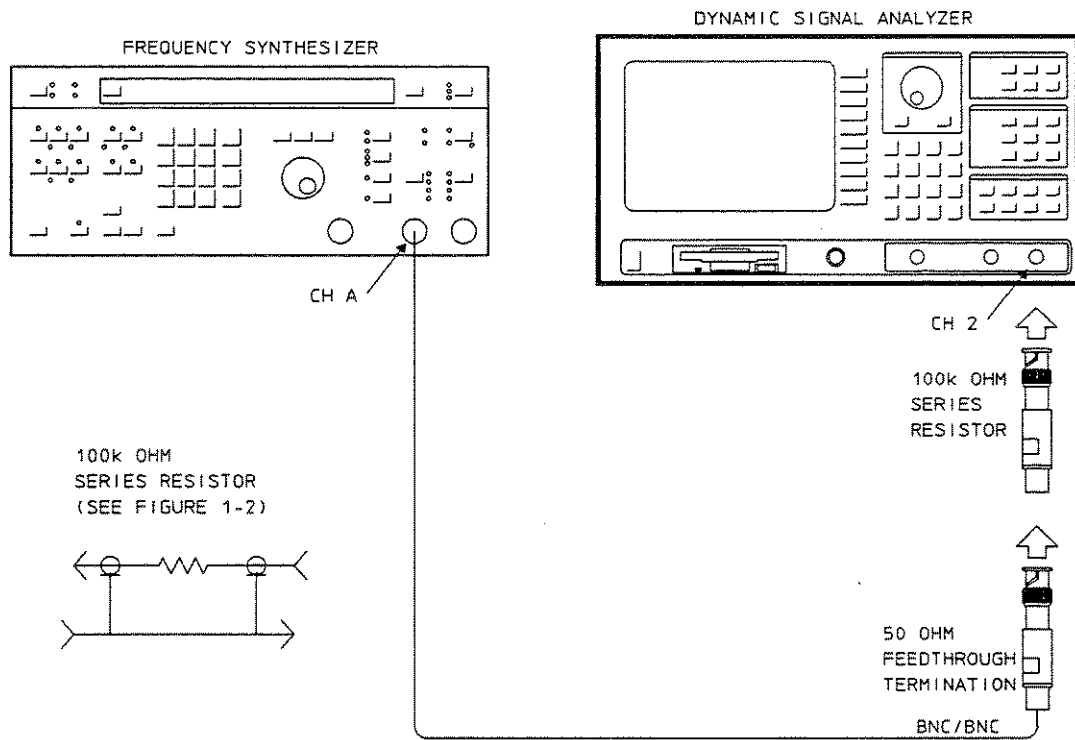
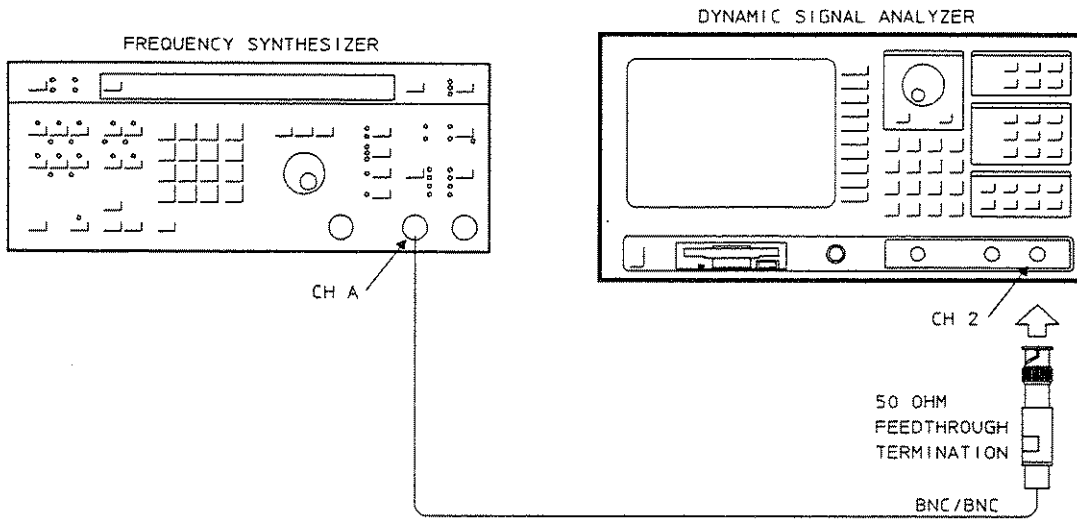

Figure 3-14. Input Capacitance Test Setup #3





**Figure 3-15. Input Capacitance Test Setup #4**

## Harmonic Distortion

### Operation Verification – No

This test is not required for Operation Verification.

This test measures the harmonic distortion generated in the HP 35665A. Using a frequency synthesizer, selected frequencies which have a harmonic at 49 kHz (for channel 2) or 99 kHz (for channel 1) are connected to the HP 35665A. The amplitude of the harmonic frequency is then measured and compared to specifications.

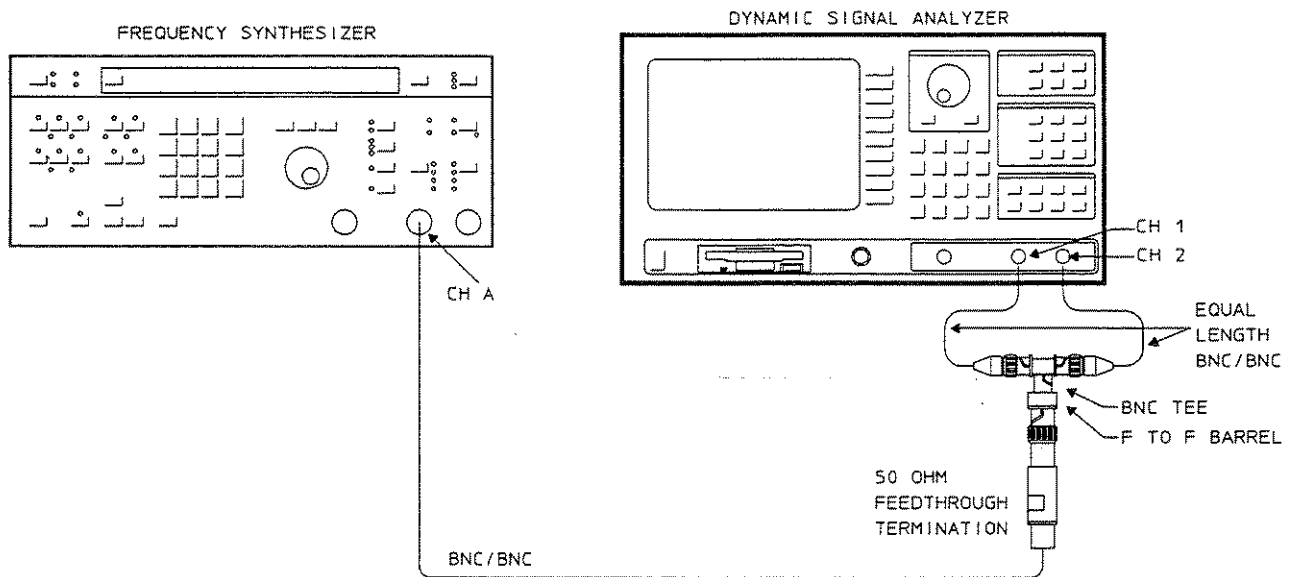
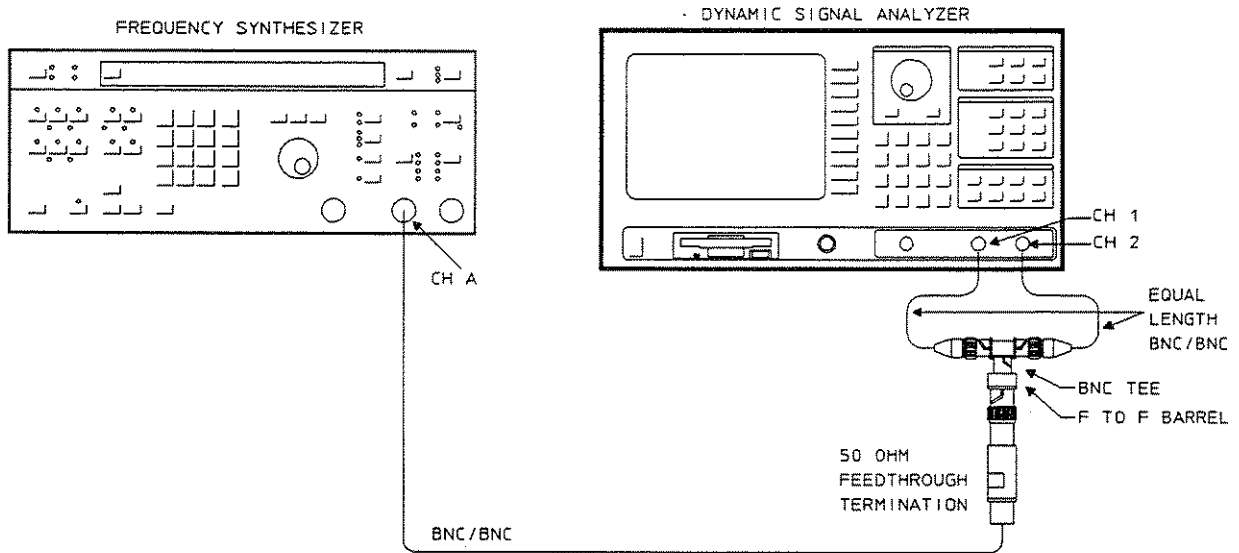

Figure 3-16. Harmonic Distortion Test Setup

## Intermodulation Distortion

**Operation Verification – No**  
 This test is not required for Operation Verification.

This test measures the level of intermodulation distortion products generated within the HP 35665A. This is done by mixing two signals to provide a modulated signal to the analyzer's input. Anytime two signals are mixed, the resultant signal includes the two fundamental frequencies plus their sum and difference frequencies (the sum and difference frequencies are the intermodulation products). The amplitude of each intermodulation product (which should be negligible) is measured with the HP 35665A to determine if it meets specifications.



**Figure 3-17. Intermodulation Distortion Test Setup**

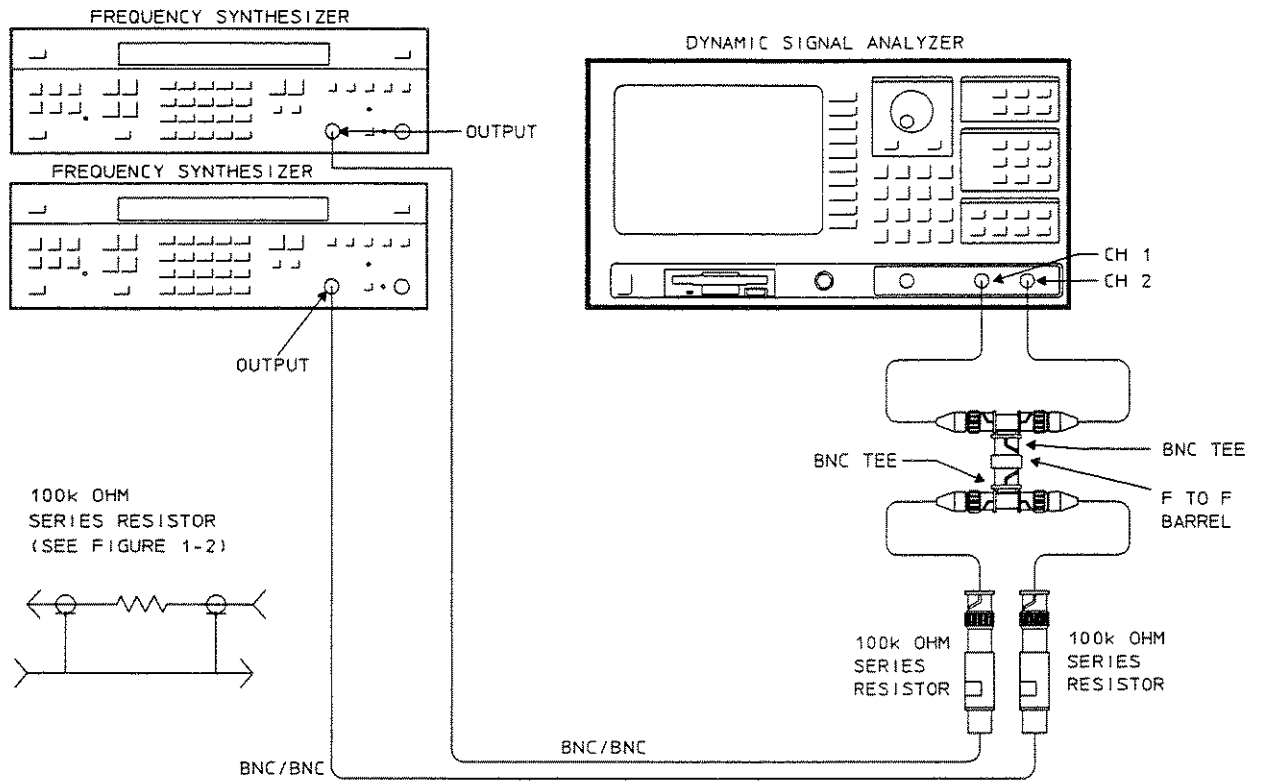
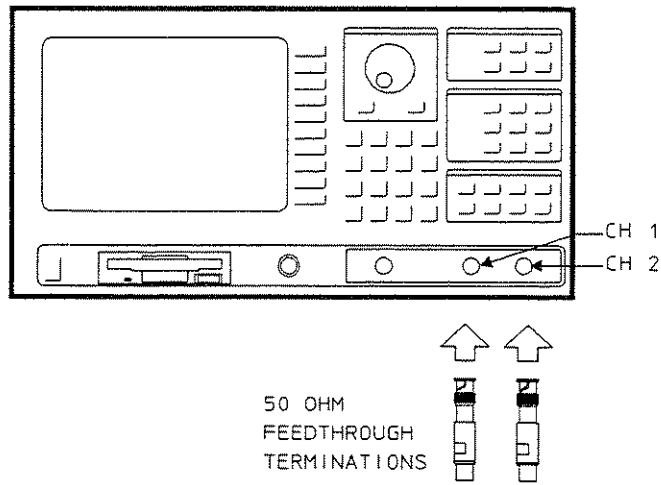

Figure 3-18. Alternate Intermod Distortion Test Setup

### Spurious Signals

**Operation Verification – Yes**  
For Operation Verification, this test is the same as the Performance Test.

This test measures the level of spurious signals generated within the HP 35665A.



**Figure 3-19. Spurious Signals Test Setup**

## Noise

### Operation Verification – Yes

For Operation Verification, this test is the same as the Performance Test.

This test measures the level of noise generated within the HP 35665A.

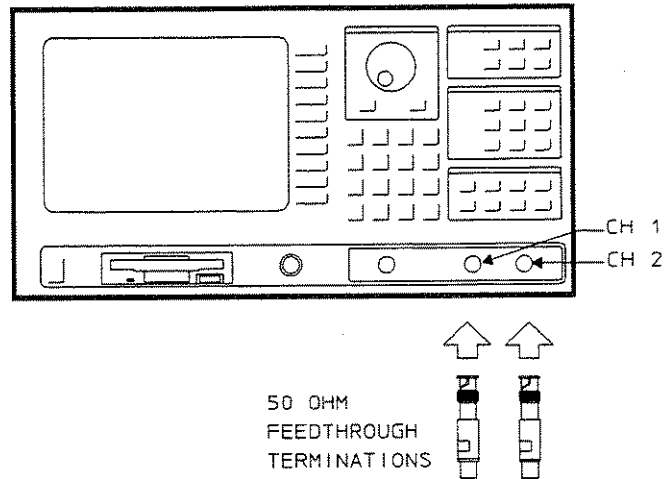
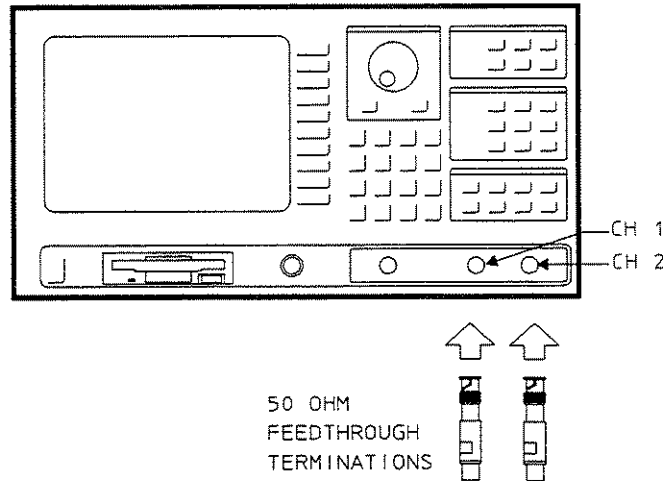

Figure 3-20. Noise Test Setup

### Cross Talk

**Operation Verification – No**  
This test is not required for Operation Verification.

This test measures the amount of energy induced by a signal on another channel. This is done by placing a high signal level on one channel and then measuring the relative signal amplitude of the other channel.



**Figure 3-21. Cross Talk Test Setup #1**

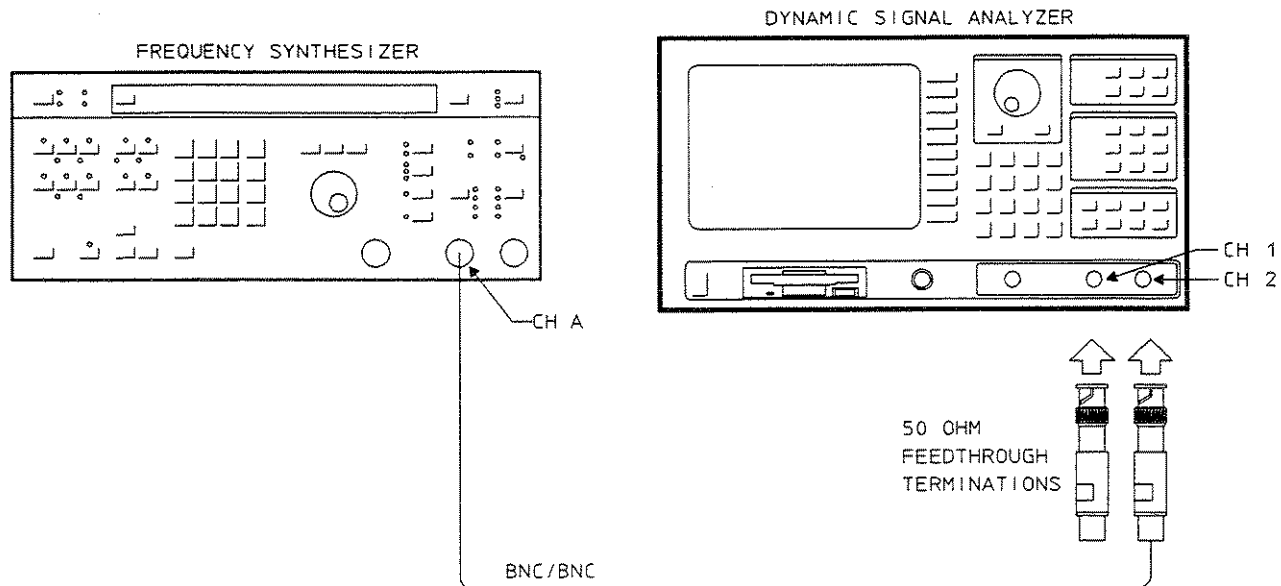

Figure 3-22. Cross Talk Test Setup #2

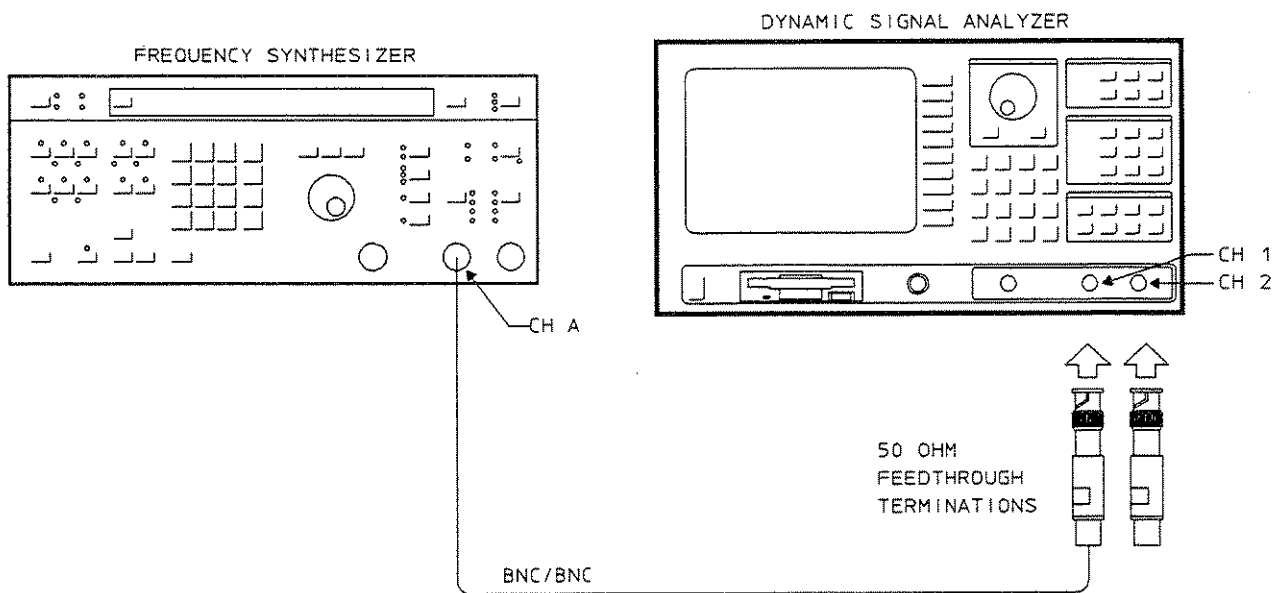

Figure 3-23. Cross Talk Test Setup #3



### Source Amplitude Accuracy

**Operation Verification – Yes**  
For Operation Verification, this test is the same as the Performance Test.

This test measures the amplitude accuracy of the source using a digital multimeter.

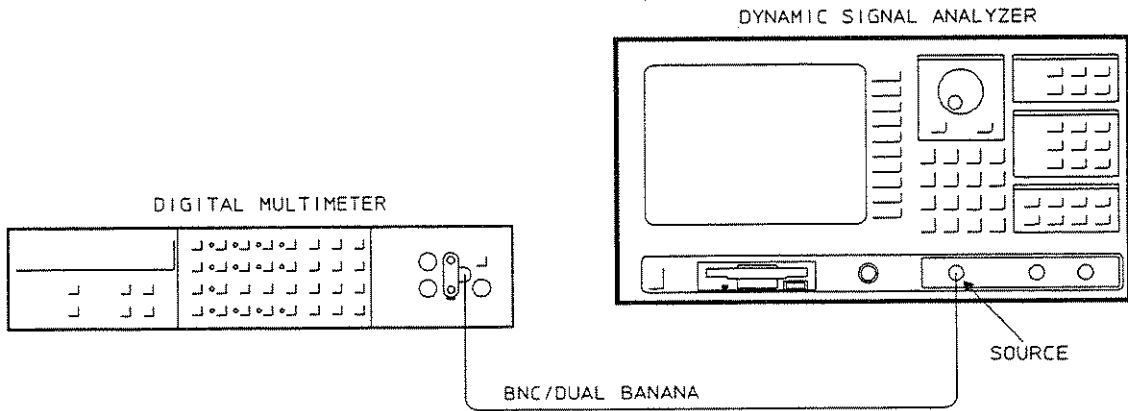

**Figure 3-24. Source Amplitude Accuracy Test Setup**

## Source Flatness

### Operation Verification – Yes

For Operation Verification, this test is the same as the Performance Test.

This test measures the flatness of the source using channel one.

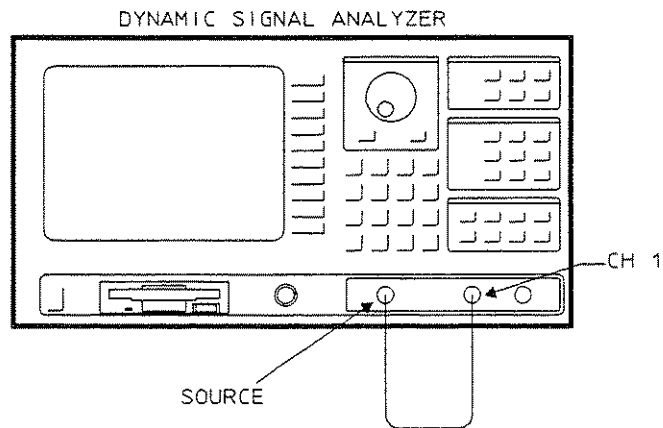
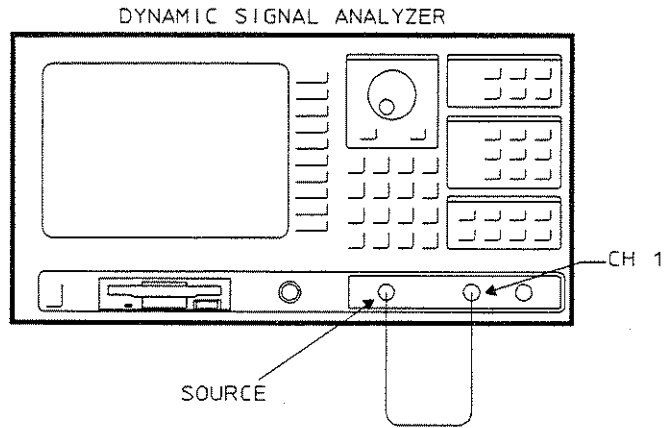

Figure 3-25. Source Flatness Test Setup

## Source Distortion

**Operation Verification – Yes**  
For Operation Verification, this test is the same as the Performance Test.

This test measures the amount of distortion generated by the source.



**Figure 3-26. Source Distortion Test Setup**

## Source Output Resistance

**Operation Verification – No**  
 This test is not required for Operation Verification.

This test measures the source output resistance of the HP 35665A. The output voltage is measured across a known load, then in an open circuit condition. The resistance is then calculated using the following formula:

$$R_s = R_l((V_{open} - V_{load})/V_{load})$$

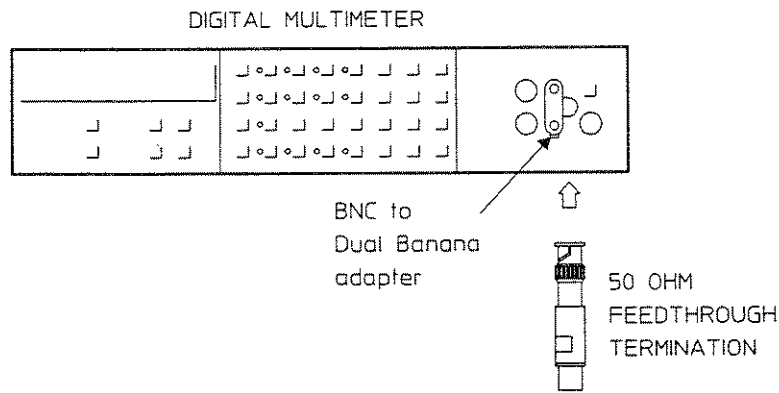

**Figure 3-27. Source Output Resistance Test Setup #1**

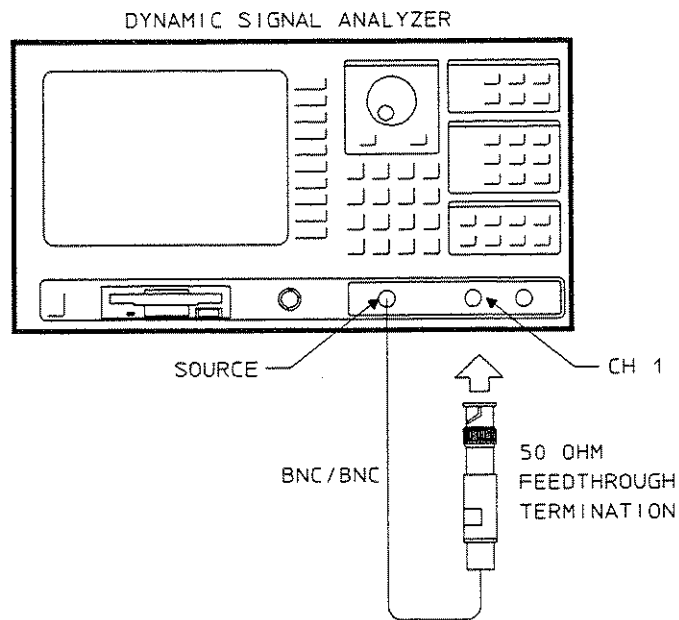

**Figure 3-28. Source Output Resistance Test Setup #2**

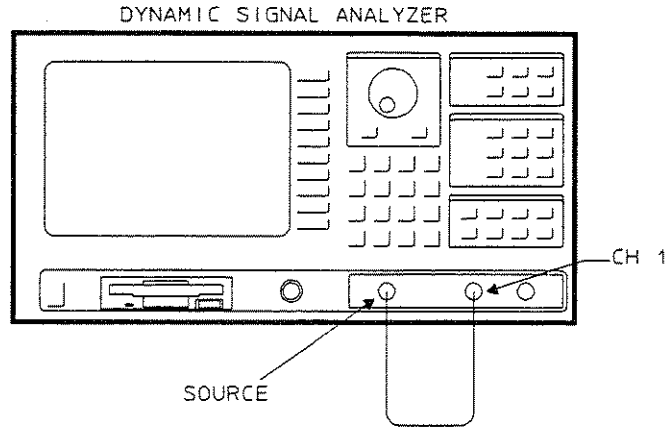

**Figure 3-29. Source Output Resistance Test Setup #3**

---

## Softkey Descriptions

---

### Note



If you do not have a keyboard connected to the analyzer, use the numeric key pad and the alpha keys to enter names or numbers. See the analyzer's help text for a description of the alpha keys.

---

### ITM\_35665A Main Menu

Load and run the ITM\_35665A program to display the following softkeys:

- |                   |   |
|-------------------|---|
| [ START TESTING ] | Press [ START TESTING ] to display a menu that allows you to start testing with any test or to select just one test in the list. Before pressing this softkey, use [ TEST CONFIG ] and [ EQUIP CONFIG ].  |
| [ TEST CONFIG ]   | Press [ TEST CONFIG ] to display the test configuration and a menu that allows you to enter the procedure, stop conditions, beeper prompt, and HP-IB address for the analyzer and printer.                |
| [ EQUIP CONFIG ]  | Press [ EQUIP CONFIG ] to display the test equipment configuration and a menu that allows you to enter the model number, calibration due date, serial number, and HP-IB address for each test instrument. |
| [ TITLE PAGE ]    | Press [ TITLE PAGE ] to display the test record title page information and a menu that allows you to enter information for the analyzer.  |
| [ STOP ITM ]      | Press [ STOP ITM ] to stop the ITM_35665A program.  |

## Start Testing Menu

Press [ START TESTING ] to display the following softkeys:

---

**Note**

When you select [ START BEGINNING ], the data is written to a file on the disk and printed only after all tests are done. When you select [ START MIDDLE ] or [ ONE TEST ], the data is printed immediately after each measurement.

---

- |                     |  |
|---------------------|--|
| [ START BEGINNING ] | Press [ START BEGINNING ] to print the test record title page information and to start the selected test procedure at the beginning.   |
| [ START MIDDLE ]    | Press [ START MIDDLE ] to display a list of all the tests in the selected procedure. Testing starts with the test you select and continues through the remainder of the tests in the list. |
| [ ONE TEST ]        | Press [ ONE TEST ] to display all the tests in the selected procedure. The test you select is the only test performed.   |
| [ RETURN ]          | Press [ RETURN ] to return to the ITM_35665A main menu.  |

Start a test to display the following softkeys:

- |                  |   |
|------------------|---|
| [ STOP TESTING ] | Press [ STOP TESTING ] to stop the test and return to the ITM_35665A main menu.             |
| [ RESTART TEST ] | Press [ RESTART TEST ] to start the current test over. Any connection prompts are repeated. |
| [ RESTART MEAS ] | Press [ RESTART MEAS ] to start the current measurement over.                               |

The following softkeys also appear when the program is waiting for you to press [ CONTINUE ]:

- |                  |   |
|------------------|---|
| [ STOP BEEPING ] | Press [ STOP BEEPING ] to turn off the beeper prompt for the remainder of this measurement. |
| [ CONTINUE ]     | Press [ CONTINUE ] to continue testing after following the directions on the display.       |

## Test Configuration Menu

---

### Note



Use the following to determine HP-IB addresses:

$$100 \times (\text{interface select code}) + (\text{primary address})$$

The interface select code for the printer and test equipment is 7 (for example, if the primary address is 8, the HP-IB address is 708).

---

Press [ TEST CONFIG ] to display the test configuration and the following softkeys:

- [ HP 35665A ADDRESS ] Press [ HP 35665A ADDRESS ] to enter the HP-IB address for the HP 35665A Dynamic Signal Analyzer.
- [ PRINTER ADDRESS ] Press [ PRINTER ADDRESS ] to enter the HP-IB address for the printer. To disable the printer, set the printer address to 0.
- [ PROCEDURE ] Press [ PROCEDURE ] to select the operation verification procedure (OP\_VERIFY) or the performance test procedure (PERFORMAN).
- [ STOP AFTER ] Press [ STOP AFTER ] to select stop after limit failure, stop after each measurement, or do not stop after a limit failure or measurement. If [ Limit Failure ] is selected, the program stops after the failing measurement is displayed but before it is printed. At this point you can continue on and print the failing measurement or restart the measurement.
- [ BEEPER ] Press [ BEEPER ] to toggle the beeper on the off. When the beeper is on, the program beeps approximately every 2 minutes while waiting for you to follow the directions on the display and press [ CONTINUE ].
- [ RETURN ] Press [ RETURN ] to return to the ITM\_35665A main menu.



## Equipment Configuration Menu

Press [ EQUIP CONFIG ] to display the test equipment configuration and the following softkeys:

---

### Note



If you select [ Other ] for model, the program prompts you to type in a model, serial number, and calibration due date but not an HP-IB address.

When entering the calibration due date, only four characters are displayed on the screen. However, you can enter up to nine characters and they will be printed.

---

- |                      |  |
|----------------------|--|
| [ AC CALIBRATO ]     | Press [ AC CALIBRATO ] to enter the model, serial number, HP-IB address, and calibration due date for the ac calibrator.   |
| [ SYNTH. 1 ]         | Press [ SYNTH. 1 ] to enter the model, serial number, HP-IB address, and calibration due date for the synthesizer.   |
| [ SYNTH. 2 ]         | Press [ SYNTH. 2 ] to enter the model, serial number, HP-IB address, and calibration due date for the second synthesizer. If the first synthesizer is an HP 3326A or if you are only performing the operation verification tests, you do not need a second synthesizer.        |
| [ LOW-D. OSCILLATO ] | Press [ LOW-D. OSCILLATO ] to enter the model, serial number, and calibration due date for the low-distortion oscillator. If the first synthesizer is an HP 3326A or if you are only performing the operation verification tests, you do not need a low-distortion oscillator. |
| [ MULTIMETER ]       | Press [ MULTIMETER ] to enter the model, serial number, HP-IB address, and calibration due date for the multimeter.  |
| [ SAVE SETUP ]       | Press [ SAVE SETUP ] to save the current equipment configuration to a file for future recall.  |
| [ RECALL SETUP ]     | Press [ RECALL SETUP ] to recall an equipment configuration that was previously saved using [ SAVE SETUP ].  |
| [ RETURN ]           | Press [ RETURN ] to return to the ITM_35665A main menu.  |

## Title Page Menu

Press [ TITLE PAGE ] to display the title page information and the following softkeys:

---

### Note



The title page information is printed at the beginning of the test procedure.

---

[ TEST FACILITY ]	Press [ TEST FACILITY ] to enter the name or number of the testing entity.
[ FACILITY ADDRESS ]	Press [ FACILITY ADDRESS ] to enter the address of the testing entity.
[ TESTED BY ]	Press [ TESTED BY ] to enter the name or number of the person performing the test.
[ REPORT NUMBER ]	Press [ REPORT NUMBER ] to enter the analyzer's report number.
[ CUSTOMER ]	Press [ CUSTOMER ] to enter the name or number of the person requesting the test.
[ SERIAL NUMBER ]	Press [ SERIAL NUMBER ] to enter the analyzer's serial number.
[ MORE ]	Press [ MORE ] to display the next page.
[ RETURN ]	Press [ RETURN ] to return to the ITM_35665A main menu.
[ OPTIONS ]	Press [ OPTIONS ] to enter the analyzer's options.
[ DATE ]	Press [ DATE ] to enter the test date.
[ TEMP ]	Press [ TEMP ] to enter the temperature of the environment during the test.
[ HUMIDITY ]	Press [ HUMIDITY ] to enter the humidity of the environment during the test.
[ LINE FREQUENCY ]	Press [ LINE FREQUENCY ] to enter the power line frequency.
[ MORE ]	Press [ MORE ] to display the first page.
[ RETURN ]	Press [ RETURN ] to return to the ITM_35665A main menu.

### Measurement Uncertainty

Performance Test	Using Recommended Test Equipment		Using Other Test Equipment	
	Measurement Uncertainty	Ratio	Measurement Uncertainty	Ratio
Self Test	NA <sup>1</sup>	NA <sup>1</sup>	NA <sup>1</sup>	NA <sup>1</sup>
DC Offset	NA <sup>1</sup>	NA <sup>1</sup>	NA <sup>1</sup>	NA <sup>1</sup>
Amplitude Accuracy				
51 dBVrms	± 0.0195 dB	7.6:1		
43 dBVrms	± 0.008404 dB	>10:1		
35 dBVrms	± 0.00397 dB	>10:1		
27 dBVrms	± 0.0029 dB	>10:1		
11 dBVrms	± 0.000954 dB	>10:1		
1 dBVrms	± 0.0013 dB	>10:1		
9 dBVrms	± 0.000954 dB	>10:1		
19 dBVrms	± 0.000807 dB	>10:1		
27 dBVrms	± 0.00117 dB	>10:1		
Flatness				
49 kHz, 11 dBVrms	± 0.0044 dB	>10:1		
49 kHz, 9 dBVrms	± 0.0036 dB	>10:1		
49 kHz, 27 dBVrms	± 0.0049 dB	>10:1		
99 kHz, 9 dBVrms	± 0.0046 dB	>10:1		
99 kHz, 27 dBVrms	± 0.0103 dB	>10:1		
Amplitude Linearity				
4.4667 Vrms	± 0.0020 dB	>10:1		
0.89125 Vrms	± 0.0020 dB	>10:1		
0.17783 Vrms	± 0.0026 dB	>10:1		
0.035481 Vrms	± 0.0046 dB	>10:1		
0.0070795 Vrms	± 0.0092 dB	>10:1		
Amp Phase Match	± 0.000001 dB ± 0.000001 deg	10:1 10:1		
AntiAlias Filter				
80.072 kHz	± 0.4 dB	NA <sup>2</sup>		NA <sup>2</sup>
162.144 kHz	± 0.6 dB	NA <sup>2</sup>		NA <sup>2</sup>
Frequency Accuracy	± 5 ppm	6:1		

<sup>1</sup> internal test

<sup>2</sup> open ended specification

Performance Test	Using Recommended Test Equipment		Using Other Test Equipment	
	Measurement Uncertainty	Ratio	Measurement Uncertainty	Ratio
Input Coupling	± 0.001 dB	NA <sup>2</sup>		NA <sup>2</sup>
Single Ch Phase Accuracy	± 0.25 deg	>10:1		
Input Resistance	17Ω	>10:1		
Input Capacitance	± 2.5 pF	NA <sup>2</sup>		NA <sup>2</sup>
Harmonic Distortion	± 2.92% of reading ± 0.025% of full scale	NA <sup>2</sup>		NA <sup>2</sup>
Intermodulation Distortion	± 2.92% of reading ± 0.025% of full scale	NA <sup>2</sup>		NA <sup>2</sup>
Spurious Signals	NA <sup>1</sup>	NA <sup>1</sup>	NA <sup>1</sup>	NA <sup>1</sup>
Noise	NA <sup>1</sup>	NA <sup>1</sup>	NA <sup>1</sup>	NA <sup>1</sup>
Cross Talk Channel to Channel Source to Input	± 0.1 dB NA <sup>1</sup>	NA <sup>2</sup> NA <sup>1</sup>	NA <sup>1</sup>	NA <sup>2</sup> NA <sup>1</sup>
Source Amplitude Accuracy 0.1 Vpk 3.0 Vpk 5.0 Vpk	± 9.8284 μVpk ± 492.84 μVpk ± 632.84 μVpk	>10:1 >10:1 >10:1		
Source Flatness	± 0.2 dB	4.4:1		
Source Distortion	± 2.92% of reading ± 0.025% of full scale	NA <sup>2</sup>		NA <sup>2</sup>
Source Output Resistance	± 2.92% of reading ± 0.025% of full scale	NA <sup>2</sup>		NA <sup>2</sup>

<sup>1</sup> internal test

<sup>2</sup> open ended specification

---

## Performance Test Record

Test Facility and Address \_\_\_\_\_

Test Performed By \_\_\_\_\_

Report Number \_\_\_\_\_

Customer \_\_\_\_\_

Serial Number \_\_\_\_\_

Installed Options \_\_\_\_\_

Test Date \_\_\_\_\_

Temperature \_\_\_\_\_

Humidity \_\_\_\_\_

Power Line Frequency \_\_\_\_\_

Serial Number: \_\_\_\_\_ Report Number: \_\_\_\_\_ Test Date: \_\_\_/\_\_\_/\_\_\_

**Test Equipment:**

**AC Calibrator**

Model \_\_\_\_\_

Serial Number \_\_\_\_\_

Calibration Due Date \_\_\_\_\_

**Frequency Synthesizer**

Model \_\_\_\_\_

Serial Number \_\_\_\_\_

Calibration Due Date \_\_\_\_\_

**Frequency Synthesizer (if needed)**

Model \_\_\_\_\_

Serial Number \_\_\_\_\_

Calibration Due Date \_\_\_\_\_

**Low-Distortion Oscillator (if needed)**

Model \_\_\_\_\_

Serial Number \_\_\_\_\_

Calibration Due Date \_\_\_\_\_

**Digital Multimeter**

Model \_\_\_\_\_

Serial Number \_\_\_\_\_

Calibration Due Date \_\_\_\_\_

Serial Number: \_\_\_\_\_ Report Number: \_\_\_\_\_ Test Date: \_\_\_/\_\_\_/\_\_\_

**Self Test**

Measurement	Lower Limit	Upper Limit	Measured Value	Pass/Fail
Long Confidence	1			

**DC Offset**

Specification:

+27 dBVrms to -35 dBVrms ranges <-30 dBfs

-37 dBVrms to -51 dBVrms ranges <-20 dBfs

Measurement	Lower Limit	Upper Limit (dBVrms)	Measured Value (dBVrms)	Pass/Fail
-51 dBVrms, Ch 1		-71		
-51 dBVrms, Ch 2		-71		
-35 dBVrms, Ch 1		-65		
-35 dBVrms, Ch 2		-65		

Serial Number: \_\_\_\_\_ Report Number: \_\_\_\_\_ Test Date: \_\_\_/\_\_\_/\_\_\_

**Amplitude Accuracy**

Specification:

Full scale accuracy at 1 kHz  $\pm$  0.1 dB

Measurement	Lower Limit (dBVrms)	Upper Limit (dBVrms)	Measured Value (dBVrms)	Pass/Fail
-51 dBVrms, Ch 1	-51.1	-50.9		
-51 dBVrms, Ch 2	-51.1	-50.9		
-43 dBVrms, Ch 1	-43.1	-42.9		
-43 dBVrms, Ch 2	-43.1	-42.9		
-35 dBVrms, Ch 1	-35.1	-34.9		
-35 dBVrms, Ch 2	-35.1	-34.9		
-27 dBVrms, Ch 1	-27.1	-26.9		
-27 dBVrms, Ch 2	-27.1	-26.9		
-11 dBVrms, Ch 1	-11.1	-10.9		
-11 dBVrms, Ch 2	-11.1	-10.9		
1 dBVrms, Ch 1	0.9	1.1		
1 dBVrms, Ch 2	0.9	1.1		
9 dBVrms, Ch 1	8.9	9.1		
9 dBVrms, Ch 2	8.9	9.1		
19 dBVrms, Ch 1	18.9	19.1		
19 dBVrms, Ch 2	18.9	19.1		
27 dBVrms, Ch 1	26.9	27.1		
27 dBVrms, Ch 2	26.9	27.1		



Serial Number: \_\_\_\_\_ Report Number: \_\_\_\_\_ Test Date: \_\_\_/\_\_\_/\_\_\_

**Flatness**Specification: Relative to 1 kHz  $\pm 0.2$  dB

Measurement	Lower Limit (dB)	Upper Limit (dB)	Measured Value (dB)	Pass/Fail
-11 dBVrms, 49 kHz, Ch 1	-0.2	0.2		
-11 dBVrms, 49 kHz, Ch 2	-0.2	0.2		
9 dBVrms, 49 kHz, Ch 1	-0.2	0.2		
9 dBVrms, 49 kHz, Ch 2	-0.2	0.2		
27 dBVrms, 49 kHz, Ch 1	-0.2	0.2		
27 dBVrms, 49 kHz, Ch 2	-0.2	0.2		
9 dBVrms, 99 kHz, Ch 1	-0.2	0.2		
27 dBVrms, 99 kHz, Ch 1	-0.2	0.2		

**Amplitude Linearity**Specification:  $\pm 0.58\%$  of reading  
 $\pm 0.25\%$  of full scale

Measurement	Lower Limit (dB)	Upper Limit (dB)	Measured Value (dB)	Pass/Fail
4.4667 Vrms, Ch 1	-0.0609	0.0609		
4.4667 Vrms, Ch 2	-0.0609	0.0609		
0.89125 Vrms, Ch 1	-0.105	0.104		
0.89125 Vrms, Ch 2	-0.105	0.104		
0.17783 Vrms, Ch 1	-0.328	0.319		
0.17783 Vrms, Ch 2	-0.328	0.319		
35.481 mVrms, Ch 1	-1.54	1.32		
35.481 mVrms, Ch 2	-1.54	1.32		
7.0795 mVrms, Ch 1	-13.63	5.11		
7.0795 mVrms, Ch 2	-13.63	5.11		

Serial Number: \_\_\_\_\_ Report Number: \_\_\_\_\_ Test Date: \_\_\_/\_\_\_/\_\_\_

**Amp\_Phase Match (Amplitude and Phase Match)**

Specification:  $\pm 0.04$  dB  
 $\pm 0.5$  deg

Measurement	Lower Limit	Upper Limit	Measured Value	Pass/Fail
80 Hz, 23 dBV, Min Amp	-0.04 dB	0.04 dB		
80 Hz, 23 dBV, Max Amp	-0.04 dB	0.04 dB		
3.84 kHz, 1 dBV, Min Amp	-0.04 dB	0.04 dB		
3.84 kHz, 1 dBV, Max Amp	-0.04 dB	0.04 dB		
0 Hz, 7 dBV, Min Amp	-0.04 dB	0.04 dB		
0 Hz, 7 dBV, Max Amp	-0.04 dB	0.04 dB		
80 Hz, 23 dBV, Min Phase	-0.5 deg	0.5 deg		
80 Hz, 23 dBV, Max Phase	-0.5 deg	0.5 deg		
3.84 kHz, 1 dBV, Min Phase	-0.5 deg	0.5 deg		
3.84 kHz, 1 dBV, Max Phase	-0.5 deg	0.5 deg		
0 Hz, 7 dBV, Min Phase	-0.5 deg	0.5 deg		
0 Hz, 7 dBV, Max Phase	-0.5 deg	0.5 deg		

**Anti-Alias Filter**

Specification:  $< -81$  dBVrms

Measurement	Lower Limit	Upper Limit (dBVrms)	Measured Value (dBVrms)	Pass/Fail
162.144 kHz, Ch 1		-81		
81.072 kHz, Ch 1		-81		
81.072 kHz, Ch 2		-81		

**Frequency Accuracy**

Specification:  $\pm 30$  ppm

Measurement	Lower Limit (kHz)	Upper Limit (kHz)	Measured Value (kHz)	Pass/Fail
100 kHz	99.997	100.003		

Serial Number: \_\_\_\_\_ Report Number: \_\_\_\_\_ Test Date: \_\_\_/\_\_\_/\_\_\_

**Input Coupling**

Specification: &lt;3 dB

Measurement	Lower Limit	Upper Limit (dB)	Measured Value (dB)	Pass/Fail
dc - ac, Ch 1		3		
dc - ac, Ch 2		3		

**Single Ch Phase Accuracy**Specification:  $\pm 4$  deg

Measurement	Lower Limit (deg)	Upper Limit (deg)	Measured Value (deg)	Pass/Fail
Positive slope, Ch 1	-94	-86		
Positive slope, Ch 2	-94	-86		
Negative slope, Ch 1	86	94		
Negative slope, Ch 2	86	94		

**Input Resistance**Specification:  $1 \text{ M}\Omega \pm 10\%$ 

Measurement	Lower Limit (M $\Omega$ )	Upper Limit (M $\Omega$ )	Measured Value (M $\Omega$ )	Pass/Fail
27 dBVrms, Ch 1	0.9	1.1		
9 dBVrms, Ch 1	0.9	1.1		
-11 dBVrms, Ch 1	0.9	1.1		
27 dBVrms, Ch 2	0.9	1.1		
9 dBVrms, Ch 2	0.9	1.1		
-11 dBVrms, Ch 2	0.9	1.1		

Serial Number: \_\_\_\_\_ Report Number: \_\_\_\_\_ Test Date: \_\_\_/\_\_\_/\_\_\_

**Input Capacitance**

Specification: <100 pF

Measurement	Lower Limit	Upper Limit (pF)	Measured Value (pF)	Pass/Fail
Channel 1		100		
Channel 2		100		

**Harmonic Distortion**

Specification: <-72 dBfs

Measurement	Lower Limit	Upper Limit (dBVrms)	Measured Value (dBVrms)	Pass/Fail
24.96 kHz, 2nd, Ch 1		-71		
24.96 kHz, 2nd, Ch 2		-71		
16.64 kHz, 3rd, Ch 1		-71		
16.64 kHz, 3rd, Ch 2		-71		
49.92 kHz, 2nd, Ch 1		-71		
33.28 kHz, 3rd, Ch 1		-71		
24.96 kHz, 4th, Ch 1		-71		
19.97 kHz, 5th, Ch 1		-71		

Serial Number: \_\_\_\_\_ Report Number: \_\_\_\_\_ Test Date: \_\_\_/\_\_\_/\_\_\_

**Intermodulation Distortion**

Specification: &lt;-72 dBfs

Measurement	Lower Limit	Upper Limit (dBVrms)	Measured Value (dBVrms)	Pass/Fail
20.25 kHz, Ch 1		-83		
20.25 kHz, Ch 2		-83		
30.50 kHz, Ch 1		-83		
30.50 kHz, Ch 2		-83		
1 kHz, Ch 1		-83		
1 kHz, Ch 2		-83		
50 kHz, Ch 1		-83		
50 kHz, Ch 2		-83		
10 kHz, Ch 1		-83		
79 kHz, Ch 1		-83		

Serial Number: \_\_\_\_\_ Report Number: \_\_\_\_\_ Test Date: \_\_\_/\_\_\_/\_\_\_

**Spurious Signals**

Specification: <-72 dBfs

Measurement	Lower Limit	Upper Limit (dBVrms)	Measured Value (dBVrms)	Pass/Fail
160 Hz Start, Ch 1		-123		
160 Hz Start, Ch 2		-123		
360 Hz Start, Ch 1		-123		
360 Hz Start, Ch 2		-123		
560 Hz Start, Ch 1		-123		
560 Hz Start, Ch 2		-123		
760 Hz Start, Ch 1		-123		
760 Hz Start, Ch 2		-123		
1.28 kHz Start, Ch 1		-123		
1.28 kHz Start, Ch 2		-123		
24 kHz Start, Ch 1		-123		
24 kHz Start, Ch 2		-123		
30 kHz Start, Ch 1		-123		
30 kHz Start, Ch 2		-123		
34.2 kHz Start, Ch 1		-123		
34.2 kHz Start, Ch 2		-123		
49 kHz Start, Ch 1		-123		
49 kHz Start, Ch 2		-123		
61 kHz Start, Ch 1		-123		
68 kHz Start, Ch 1		-123		
74 kHz Start, Ch 1		-123		
76 kHz Start, Ch 1		-123		
92 kHz Start, Ch 1		-123		
100 kHz Start, Ch 1		-123		



Serial Number: \_\_\_\_\_ Report Number: \_\_\_\_\_ Test Date: \_\_\_/\_\_\_/\_\_\_

**Source Flatness**

Specification:  $\pm 1$  dB

Measurement	Lower Limit (dB)	Upper Limit (dB)	Measured Value (dB)	Pass/Fail
10 kHz	-1	1		
50 kHz	-1	1		
99 kHz	-1	1		

**Source Distortion**

Specification: 0 to 10 kHz < -60 dBc  
> 10 kHz < -40 dBc

Measurement	Lower Limit	Upper Limit (dBc)	Measured Value (dBc)	Pass/Fail
10 kHz		-60		
100 kHz		-40		

**Source Output Resistance**

Specification:  $< 5\Omega$

Measurement	Lower Limit	Upper Limit ( $\Omega$ )	Measured Value ( $\Omega$ )	Pass/Fail
Resistance		5		



---

## Operation Verification Test Record

Test Facility and Address \_\_\_\_\_

Test Performed By \_\_\_\_\_

Report Number \_\_\_\_\_

Customer \_\_\_\_\_

Serial Number \_\_\_\_\_

Installed Options \_\_\_\_\_

Test Date \_\_\_\_\_

Temperature \_\_\_\_\_

Humidity \_\_\_\_\_

Power Line Frequency \_\_\_\_\_

Serial Number: \_\_\_\_\_ Report Number: \_\_\_\_\_ Test Date: \_\_\_/\_\_\_/\_\_\_

**Self Test**

Measurement	Lower Limit	Upper Limit	Measured Value	Pass/Fail
Long Confidence	1			

**DC Offset**

Specification: +27 dBVrms to -35 dBVrms ranges <-30 dBfs  
 -37 dBVrms to -51 dBVrms ranges <-20 dBfs

Measurement	Lower Limit	Upper Limit (dBVrms)	Measured Value (dBVrms)	Pass/Fail
-51 dBVrms, Ch 1		-71		
-51 dBVrms, Ch 2		-71		
-35 dBVrms, Ch 1		-65		
-35 dBVrms, Ch 2		-65		

**Amplitude Accuracy**

Specification: Full scale accuracy at 1 kHz  $\pm$  0.1 dB

Measurement	Lower Limit (dBVrms)	Upper Limit (dBVrms)	Measured Value (dBVrms)	Pass/Fail
-51 dBVrms, Ch 1	-51.1	-50.9		
-51 dBVrms, Ch 2	-51.1	-50.9		
-27 dBVrms, Ch 1	-27.1	-26.9		
-27 dBVrms, Ch 2	-27.1	-26.9		
-11 dBVrms, Ch 1	-11.1	-10.9		
-11 dBVrms, Ch 2	-11.1	-10.9		
9 dBVrms, Ch 1	8.9	9.1		
9 dBVrms, Ch 2	8.9	9.1		
27 dBVrms, Ch 1	26.9	27.1		
27 dBVrms, Ch 2	26.9	27.1		

Serial Number: \_\_\_\_\_ Report Number: \_\_\_\_\_ Test Date: \_\_\_/\_\_\_/\_\_\_

**Flatness**

Specification: Relative to 1 kHz  $\pm$  0.2 dB

Measurement	Lower Limit (dB)	Upper Limit (dB)	Measured Value (dB)	Pass/Fail
-11 dBVrms, 49 kHz, Ch 1	-0.2	0.2		
-11 dBVrms, 49 kHz, Ch 2	-0.2	0.2		
9 dBVrms, 49 kHz, Ch 1	-0.2	0.2		
9 dBVrms, 49 kHz, Ch 2	-0.2	0.2		
27 dBVrms, 49 kHz, Ch 1	-0.2	0.2		
27 dBVrms, 49 kHz, Ch 2	-0.2	0.2		
9 dBVrms, 99 kHz, Ch 1	-0.2	0.2		
27 dBVrms, 99 kHz, Ch 1	-0.2	0.2		

**Amp\_Phase Match (Amplitude and Phase Match)**

Specification:  $\pm$  0.04 dB  
 $\pm$  0.5 deg

Measurement	Lower Limit	Upper Limit	Measured Value	Pass/Fail
80 Hz, 23 dBV, Min Amp	-0.04 dB	0.04 dB		
80 Hz, 23 dBV, Max Amp	-0.04 dB	0.04 dB		
3.84 kHz, 1 dBV, Min Amp	-0.04 dB	0.04 dB		
3.84 kHz, 1 dBV, Max Amp	-0.04 dB	0.04 dB		
0 Hz, 7 dBV, Min Amp	-0.04 dB	0.04 dB		
0 Hz, 7 dBV, Max Amp	-0.04 dB	0.04 dB		
80 Hz, 23 dBV, Min Phase	-0.5 deg	0.5 deg		
80 Hz, 23 dBV, Max Phase	-0.5 deg	0.5 deg		
3.84 kHz, 1 dBV, Min Phase	-0.5 deg	0.5 deg		
3.84 kHz, 1 dBV, Max Phase	-0.5 deg	0.5 deg		
0 Hz, 7 dBV, Min Phase	-0.5 deg	0.5 deg		
0 Hz, 7 dBV, Max Phase	-0.5 deg	0.5 deg		

Serial Number: \_\_\_\_\_ Report Number: \_\_\_\_\_ Test Date: \_\_\_/\_\_\_/\_\_\_

**Frequency Accuracy**

Specification:  $\pm 30$  ppm

Measurement	Lower Limit (kHz)	Upper Limit (kHz)	Measured Value (kHz)	Pass/Fail
100 kHz	99.997	100.003		

**Single Ch Phase Accuracy**

Specification:  $\pm 4$  deg

Measurement	Lower Limit (deg)	Upper Limit (deg)	Measured Value (deg)	Pass/Fail
Positive slope, Ch 1	-94	-86		
Positive slope, Ch 2	-94	-86		
Negative slope, Ch 1	86	94		
Negative slope, Ch 2	86	94		

Serial Number: \_\_\_\_\_ Report Number: \_\_\_\_\_ Test Date: \_\_\_/\_\_\_/\_\_\_

**Spurious Signals**

Specification: <72 dBfs

Measurement	Lower Limit	Upper Limit (dBVrms)	Measured Value (dBVrms)	Pass/Fail
160 Hz Start, Ch 1		-123		
160 Hz Start, Ch 2		-123		
360 Hz Start, Ch 1		-123		
360 Hz Start, Ch 2		-123		
560 Hz Start, Ch 1		-123		
560 Hz Start, Ch 2		-123		
760 Hz Start, Ch 1		-123		
760 Hz Start, Ch 2		-123		
1.28 kHz Start, Ch 1		-123		
1.28 kHz Start, Ch 2		-123		
24 kHz Start, Ch 1		-123		
24 kHz Start, Ch 2		-123		
30 kHz Start, Ch 1		-123		
30 kHz Start, Ch 2		-123		
34.2 kHz Start, Ch 1		-123		
34.2 kHz Start, Ch 2		-123		
49 kHz Start, Ch 1		-123		
49 kHz Start, Ch 2		-123		
61 kHz Start, Ch 1		-123		
68 kHz Start, Ch 1		-123		
74 kHz Start, Ch 1		-123		
76 kHz Start, Ch 1		-123		
92 kHz Start, Ch 1		-123		
100 kHz Start, Ch 1		-123		



Serial Number: \_\_\_\_\_ Report Number: \_\_\_\_\_ Test Date: \_\_\_/\_\_\_/\_\_\_

**Source Flatness**

Specification:  $\pm 1$  dB

Measurement	Lower Limit (dB)	Upper Limit (dB)	Measured Value (dB)	Pass/Fail
10 kHz	-1	1		
50 kHz	-1	1		
99 kHz	-1	1		

**Source Distortion**

Specification: 0 to 10 kHz < -60 dBc  
> 10 kHz < -40 dBc

Measurement	Lower Limit	Upper Limit (dBc)	Measured Value (dBc)	Pass/Fail
10 kHz		-60		
100 kHz		-40		





# Index

---

## A

- accessories 1-2
- amp\_phase match performance test
  - description and setup 3-23
  - specification 1-9
- amplitude accuracy performance test
  - description and setup 3-20
  - specification 1-7
- amplitude linearity performance test
  - description and setup 3-22
  - specification 1-7
- anti-alias filter performance test
  - description and setup 3-24
  - specification 1-8
- assistance 2-9

## C

- cleaning screen 2-6
- connectors
  - front panel 1-1
  - rear panel 1-1
- cooling 2-5
- cross talk performance test
  - description and setup 3-37
  - specification 1-9

## D

- dc offset performance test
  - description and setup 3-19
  - specification 1-8
- disk drive assembly
  - transportation disk 2-1
- display assembly
  - cleaning screen 2-6

## E

- equipment required 1-4
- external keyboard
  - installation 2-7

## F

- firmware version 1-3
- flatness performance test
  - description and setup 3-21
  - specification 1-7

- frequency accuracy performance test
  - description and setup 3-25
  - specification 1-7
- front panel connectors 1-1
- fuse 2-2

## G

- grounding requirements 2-3

## H

- hardkeys 3-1
- harmonic distortion performance test
  - description and setup 3-32
  - specification 1-8
- HP-IB
  - connector 2-6

## I

- incoming inspection 2-1
- index
  - See also* second
- input capacitance performance test
  - description and setup 3-29
  - specification 1-9
- input coupling performance test
  - description and setup 3-26
  - specification 1-9
- input resistance performance test
  - description and setup 3-28
  - specification 1-9
- installation
  - bench 2-7
  - keyboard 2-7
  - rack mount 2-7
- intermodulation distortion performance test
  - description and setup 3-33
  - specification 1-8

## K

- keyboard
  - See* external keyboard
  - See* front panel

## L

- line-voltage selector switch 2-2

## M

measurement uncertainty 3-5, 3-49

## N

noise performance test  
description and setup 3-36  
specification 1-8

## O

operating environment 2-5  
operation verification  
confidence level 3-6  
test duration 2-1  
test list 3-6  
options 1-1

## P

performance test  
confidence level 3-6  
cycle 3-3  
test duration 2-1  
test list 3-6  
versus specification 3-7  
performance test software  
loading program 3-8  
manual mode 3-14  
program controlled equipment 3-4  
semiautomated mode 3-9  
softkey descriptions 3-44  
without a printer 3-12  
port 1  
connector 2-5  
power  
cables 2-3  
consumption 2-2  
requirements 2-2

## R

rear panel connectors 1-1  
recommended test equipment 1-4

## S

safety  
*See* front matter  
screen  
*See* display assembly  
self test  
performance test 3-18  
serial number 1-3  
shipment 2-10

single ch phase accuracy performance test  
description and setup 3-27  
specification 1-8  
softkeys 3-1  
software version 1-3  
source amplitude accuracy performance test  
description and setup 3-39  
specification 1-10  
source distortion performance test  
description and setup 3-41  
specification 1-10  
source flatness performance test  
description and setup 3-40  
specification 1-10  
source output resistance performance test  
description and setup 3-42  
specification 1-10  
specifications 1-7  
spurious signals performance test  
description and setup 3-35  
specification 1-8  
storage 2-9

## T

test equipment 1-4  
transportation disk 2-1

## V

voltage selector switch 2-2